

# KENWOOD

AV CONTROL CENTER

**C-V770**

**C-V700**

**C-V550**

**C-V500**

---

## INSTRUCTION MANUAL

KENWOOD CORPORATION

This manual contains instructions for four models. Model availability and features (functions) may differ depending on country and sales area.

# Before applying power

CV770/CV700/CV550/CV500 (E)/M

# 2 Before applying power

**⚠ Caution : Read this section carefully to ensure safe operation.**

Units are designed for operation as follows.

U.S.A. and Canada ..... AC120 V only  
Australia ..... AC 240 V only

Europe and U.K. .... AC 230 V only  
China ..... AC 220 V only  
\*Other countries ..... AC 110-120/220-240 V switchable

## \*AC voltage selection

### AC voltage selector switch

The AC voltage selector switch on the rear panel is set to the voltage that prevails in the area to which the unit is shipped. Before connecting the power cord to your AC outlet, make sure that the setting position of this switch matches your line voltage. If not, it must be set to your voltage in accordance with the following direction.

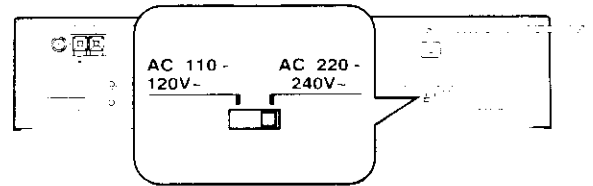





Note:  
Our warranty does not cover damage caused by excessive line voltage due to improper setting of the AC voltage selector switch.

Move switch lever to match your area's line voltage with a small screwdriver or other pointed tool.

# Safety precautions

**⚠ Caution : Read this section carefully to ensure safe operation.**





**WARNING :** TO PREVENT FIRE OR ELECTRIC SHOCK, DO NOT EXPOSE THIS APPLIANCE TO RAIN OR MOISTURE.

	<p><b>CAUTION</b> RISK OF ELECTRIC SHOCK DO NOT OPEN</p>		<p>CAUTION: TO REDUCE THE RISK OF ELECTRIC SHOCK, DO NOT REMOVE COVER (OR BACK). NO USER-SERVICEABLE PARTS INSIDE. REFER SERVICING TO QUALIFIED SERVICE PERSONNEL.</p>
	<p>THE LIGHTNING FLASH WITH ARROWHEAD SYMBOL, WITHIN AN EQUILATERAL TRIANGLE, IS INTENDED TO ALERT THE USER TO THE PRESENCE OF UNINSULATED "DANGEROUS VOLTAGE" WITHIN THE PRODUCT'S ENCLOSURE THAT MAY BE OF SUFFICIENT MAGNITUDE TO CONSTITUTE A RISK OF ELECTRIC SHOCK TO PERSONS.</p>		
	<p>THE EXCLAMATION POINT WITHIN AN EQUILATERAL TRIANGLE IS INTENDED TO ALERT THE USER TO THE PRESENCE OF IMPORTANT OPERATING AND MAINTENANCE (SERVICING) INSTRUCTIONS IN THE LITERATURE ACCOMPANYING THE APPLIANCE.</p>		

# Unpacking

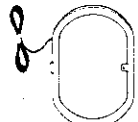
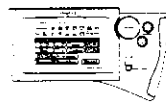
Unpack the unit carefully and make sure that all accessories are put aside so they will not be lost. Examine the unit for any possibility of shipping damage. If your unit is damaged or fails to operate, notify your dealer immediately. If your unit was shipped to you directly, notify the shipping company without delay. Only the consignee (the person or company receiving the unit) can file a claim against the carrier for shipping damage. We recommend that you retain the original carton and packing materials for use should you transport or ship the unit in the future.

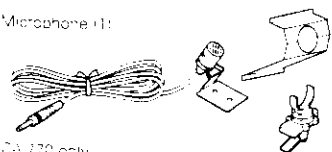
## Accessories

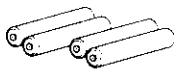
<p>FM In-ear antenna (1)</p> 	<p>AM Loop antenna (1)</p> 	<p>Graphical Remote Control Unit (1)</p> 	<p>Cable tie (2)</p> 	<p>*AC plug adaptor (1)</p> 
<p>Microphone (1)</p>  <p>CV770 only</p>	<p>Loop antenna stand (1)</p> 	<p>Batteries (R03/AAA) (4)</p> 	<p>*Use to adapt the plug on the power cord to the shape of the wall outlet. (Accessory only for regions where use is necessary.)</p>	

# Contents

Caution : Read the pages marked  carefully to ensure safe operation.

<b>Before applying power</b> .....	<b>2</b>
<i>⚠</i> Before applying power .....	2
<i>⚠</i> Safety precautions .....	2
Unpacking .....	2
<b>Contents</b> .....	<b>3</b>
<b>Special features</b> .....	<b>4</b>
<b>System connection</b> .....	<b>5</b>
Connection of audio components (CD player, cassette deck, power amplifier) .....	5
Connection of video components (LD player, VCR, cable/satellite tuner, DVD) .....	6
Digital connections .....	7
About the system control connections .....	8
Connection of flat-cable connector .....	8
Connection of antenna .....	9
<b>Controls and indicators</b> .....	<b>10</b>
<b>Setup of the Graphical Remote Control (GRC) unit</b> .....	<b>14</b>
Controls and indicators .....	14
Setting up the GRC according to your AV CONTROL CENTER (Model Type Setup) .....	15
Setting up the GRC according to the option components (Set Up) .....	16
Setting up the GRC according to other components (Set Up) .....	17
<b>Remote control of components from the GRC</b> .....	<b>18</b>
Controlling the AV CONTROL CENTER .....	18
Controlling the components connected through system control cords .....	19
<b>Convenient functions</b> .....	<b>21</b>
One-touch operation and easy operation features .....	21
<b>System component startup by voice activation (C-V770 only)</b> .....	<b>22</b>
Starting the system components by voice activation (by any person) .....	22
Auto power-save .....	22
Recording the user's own voice for voice activation (by specific person) .....	23
Starting the system by voice activation using the recorded words (by specific person) .....	23
<b>Playing music</b> .....	<b>24</b>
<b>Sound adjustment functions</b> .....	<b>25</b>
<b>Recording</b> .....	<b>27</b>
<b>Broadcast reception</b> .....	<b>28</b>
Receiving broadcast station .....	28
Storing stations automatically in preset memory (AUTO MEMORY) .....	29
Receiving a preset station .....	29
Storing radio stations manually in preset memory .....	30
Receiving a preset station .....	30
Receiving all preset stations in order (P. CALL) .....	30
<b>Ambience effects</b> .....	<b>32</b>
Sound modes .....	32
Setup for surround play .....	34
Surround play .....	36
Surround play of LD or DVD .....	37
Setup for surround play (while listening to music) .....	38
Setup of other speakers than those used by system SERIES 21 .....	42
Setup of the surround effect parameters (DSP) .....	44
<b>Clock adjustment</b> .....	<b>46</b>
Displaying the Time .....	46
<b>Timer operation</b> .....	<b>47</b>
Timer programming .....	47
Activating the timer .....	49
Sleep timer .....	50
<b>Set up code chart</b> .....	<b>51</b>
VCR Set up codes .....	51
TV Set up codes .....	52
TV Set up codes .....	53
Cable Set up codes .....	53
LD Set up codes .....	54
Satellite Set up codes .....	54
<b><i>⚠</i> Specifications</b> .....	<b>55</b>
<b>In case of difficulty</b> .....	<b>58</b>

# Special features

C-V770/C-V700/C-V550/C-V500 (En/M)

## Special features

### True home theater sound

#### Dolby Digital (AC-3)

The DOLBY DIGITAL (AC-3) mode lets you enjoy full digital surround from software processed in the Dolby Digital (AC-3) format. Dolby Digital (AC-3) provides up to 5.1 channels of independent digital audio for better sound quality and more powerful presence than conventional Dolby Surround.

#### Dolby Pro Logic & Dolby 3 Stereo

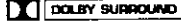
This surround system reproduces theater-like surround sound from video software marked  DOLBY SURROUND. The PRO LOGIC mode uses the built-in adaptive matrix circuit to steer the Left, Center, Right and Surround channel audio signals. The 3 STEREO mode will redirect the surround signal to the front left and right speakers when only the front and center speakers are used.

#### New DSP surround modes

The DSP (Digital Signal Processor) used for this AV CONTROL CENTER incorporates a variety of high quality adjustable sound fields like "ARENA", "JAZZ CLUB", "STADIUM", "CATHEDRAL" and "THEATER", to add the "presence" associated with an arena, jazz club or stadium (etc.) to the original signal. It is compatible with almost any kind of program source.

## Graphical Remote Control unit "GRC"

The GRC unit incorporates a large-screen LCD which displays key icons and parameters. The LCD also shows information on the operating modes of the main unit.

To improve the operability, frequently used icons are located in the higher hierarchy in the LCD display and icons which are associated between each other are shown on the same screen.

The GRC unit is a multi-function remote control unit which can be programmed to control AV components from other manufacturers than KENWOOD.

## ONE TOUCH OPERATION

Simply pressing the play key of the CD player or cassette deck turns the system on and starts playback.

## How to use this manual

In this manual, the operating procedures are described on the left half of each page and the supplementary explanation, display information and other notes on each step are described on the right half.

(Example of instructions in this manual)

### Operating procedure steps (Left half)

### Supplementary explanation (Right half)

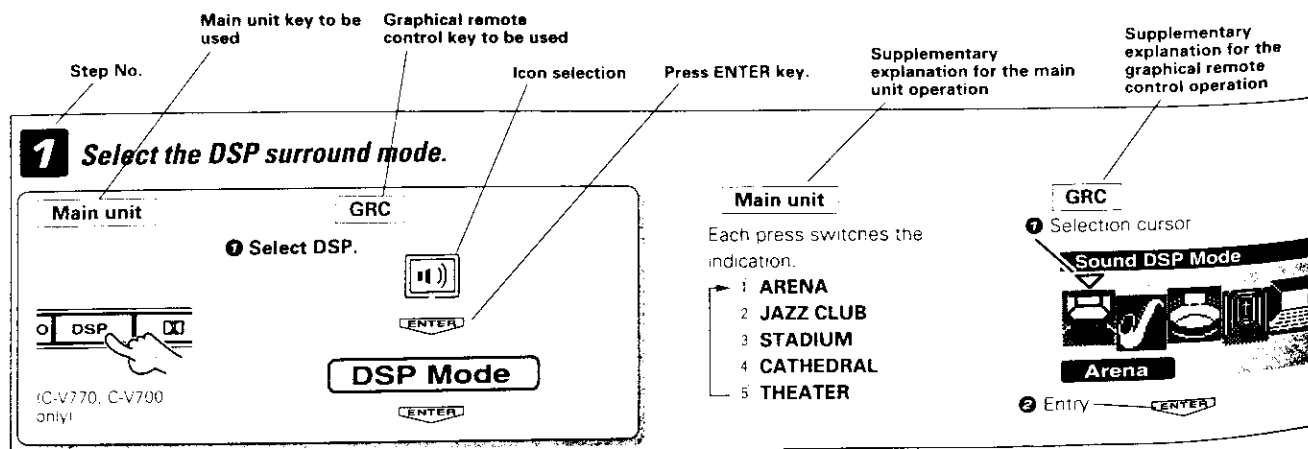

 In case the design of an operation key on the main unit differs between the C-V770/V700 and the C-V550/V500, this manual describes the key using the key name in place of using illustration.

## Connection of audio components (CD player, cassette deck, power amplifier)

Make connection as shown below.

When connecting the related system components, refer also to the instruction manuals of the related components.

⚠ Do not plug in the power lead until all connections are completed.

### Malfunction of microcomputer

If operation is not possible or erroneous display appears even though all connections have been made properly, reset the microcomputer referring to "In case of difficulty".

Analog disc turntable  
(with built-in equalizer amp)

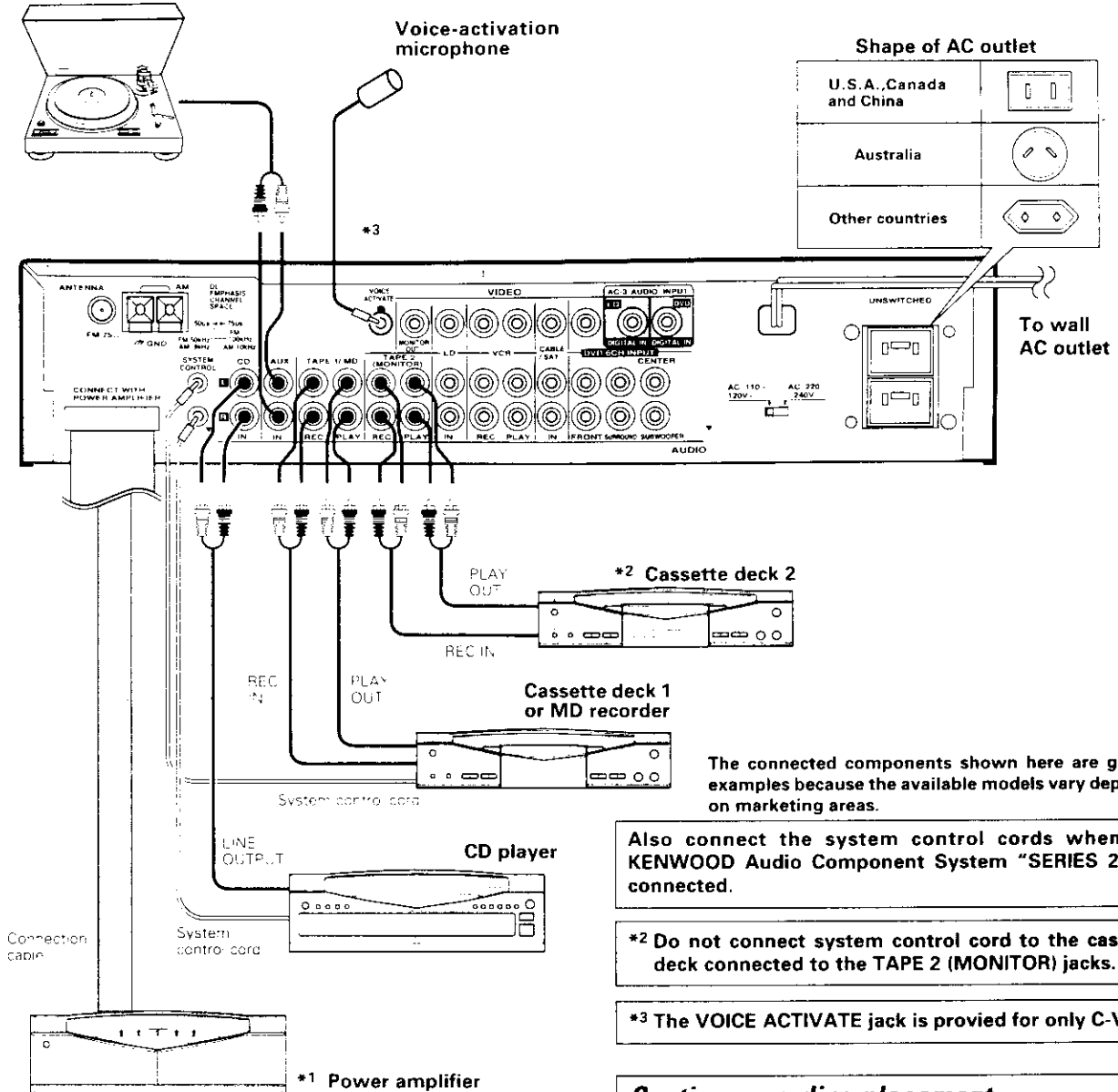

The connected components shown here are given as examples because the available models vary depending on marketing areas.

Also connect the system control cords when the KENWOOD Audio Component System "SERIES 21" is connected.

\*2 Do not connect system control cord to the cassette deck connected to the TAPE 2 (MONITOR) jacks.

\*3 The VOICE ACTIVATE jack is provided for only C-V770.

### Caution regarding placement (Except for U.S.A. and Canada)

To maintain proper ventilation, be sure to leave a space around the unit (from the largest outer dimensions including projections) equal to, or greater than, shown below.

- Left and right panels: 10 cm
- Rear panel : 10 cm
- Top panel : 50 cm

\*1 For the connection and operation procedures of the power amplifier and speakers, refer to the instruction manual of the power amplifier (M-A300 or M-A100).

# Connection of video components (LD player, VCR, cable/satellite tuner, DVD)

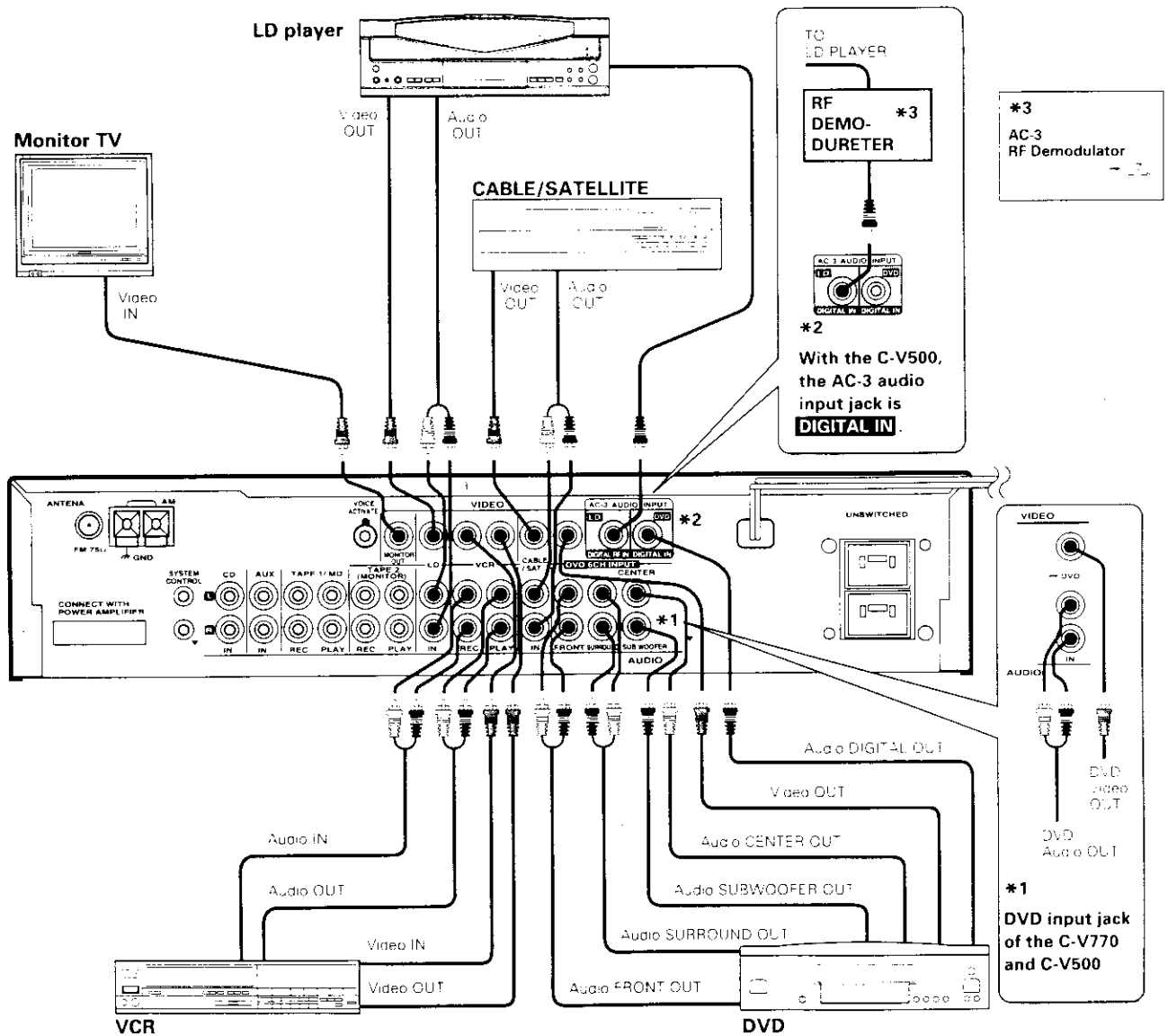

The connected components are given as examples because the available models vary depending on marketing areas.

## FM DE-EMPHASIS / CHANNEL SPACE switch (Except for U.S.A., Canada and Australia)

The FM DE-EMPHASIS / CHANNEL SPACE switch on the rear panel is set to the correct setting that prevails in the area to which the unit is shipped. However, if the FM DE-EMPHASIS / CHANNEL SPACE setting is not matched to the area where the unit is to be used; for instance, when you moved from area 1 to area 2 or vice versa, desired reception of AM / FM broadcasts is not expected. In this case, change the FM DE-EMPHASIS / CHANNEL SPACE setting in accordance with the area corresponding to the table. The FM DE-EMPHASIS is switched over at the same time.

- When changing the setting of the FM DE-EMPHASIS / CHANNEL SPACE switch, first disconnect the power cord of the amplifier, then reset the channel space switch, connect the power cord again, and turn the power on.

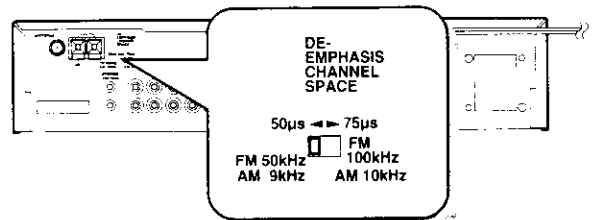

	Area	CHANNEL SPACE freq.	FM DE-EMPHASIS
1	U.S.A., Canada, Hawaii, South American countries	FM: 100kHz AM: 10kHz	75 µs
2	Other countries	FM: 50kHz AM: 9kHz	50 µs

# Digital connections

Make connections as shown below.

The digital in jacks can accept either Dolby Digital (AC-3) or PCM signals (the input signal type is detected automatically). When connecting the related system components, be sure to also refer to the instruction manuals supplied with the components you are connecting.

Do not connect the power cord to a wall outlet until all connections are completed.

Connect components capable of outputting Dolby Digital (AC-3) or standard PCM format digital signals.

## For C-V500

To connect an LD player with a DIGITAL RF OUT.

Connect the LD player to the KENWOOD RF digital demodulator (DEM-999D). Then connect the demodulator to the AC-3 AUDIO INPUT DIGITAL IN.

Connect the video signal and analog audio signals to LD jacks (See "Connection of video components".)

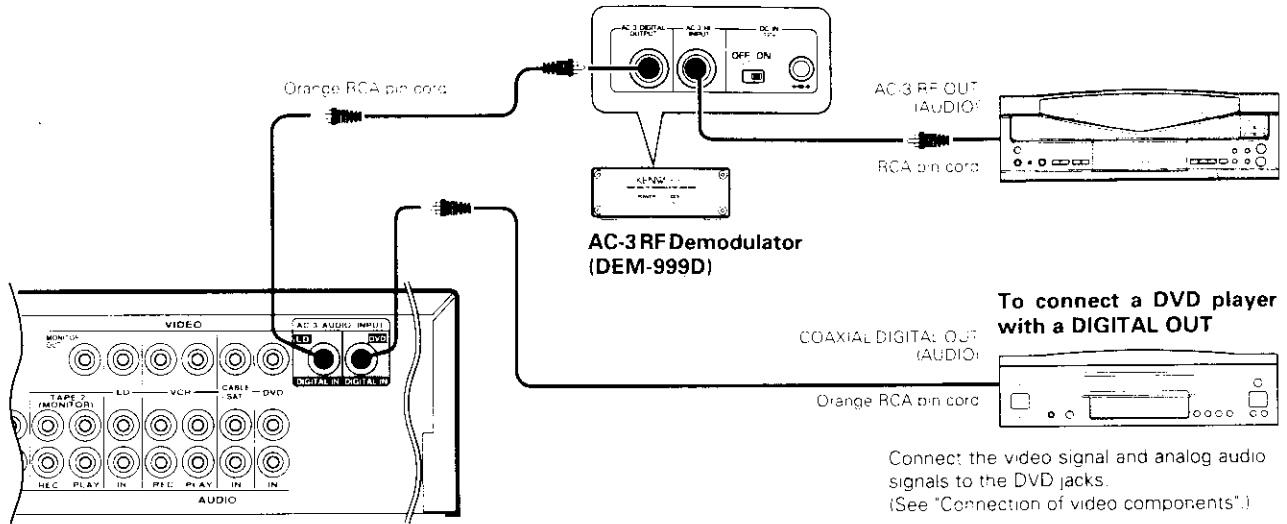

## To connect a DVD player with a DIGITAL OUT

COAXIAL DIGITAL OUT (AUDIO)  
Orange RCA pin cord

Connect the video signal and analog audio signals to the DVD jacks. (See "Connection of video components".)

The connected components are given as examples because the available models vary depending on marketing areas.

## AC-3 RF Demodulator DEM-999D



### 1 POWER indicator

Lights (red) when the power switch (5) is set to ON.

### 2 LOCK indicator

Lights when an AC-3 RF signal is input to the AC-3 RF INPUT jack (4).

### 3 AC-3 DIGITAL OUTPUT (coaxial)

Connect this jack to the LD, AC-3 AUDIO INPUT (DIGITAL), jack on your AV CONTROL CENTER.

It outputs AC-3 coaxial digital signals when the POWER (5) is set to ON and an AC-3 RF signal is input to the AC-3 RF INPUT jack (4).

### 4 AC-3 RF INPUT

Connect this jack to the AC-3 RF OUTPUT jack on your LD player.

### 5 POWER switch

Use to switch the power ON/OFF.

### 6 DC IN (12V) jack

Connect this jack and inlet power cord to the AC adaptor supplied with your demodulator. Connect the power cord to a wall outlet after completing all of the other connections.

Place the power supply away from the demodulator, AV CONTROL CENTER, and any antennas.

# About the system control connections

When this unit is connected to KENWOOD audio component system "SERIES 21", also connect them through the system control cords to allow system-control operations between components.

## Connection example

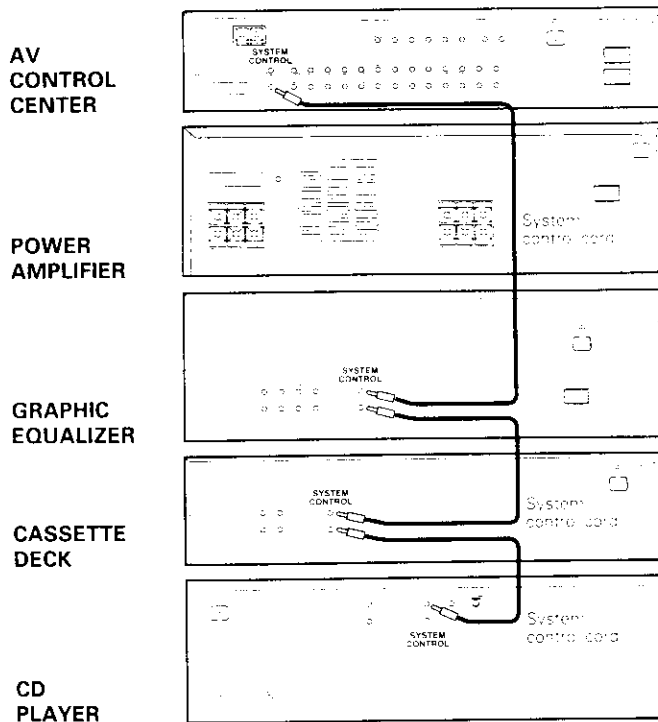

The SERIES 21 components which can be system connected with this unit include the CD player, MD recorder and D.D. player.



1. Do not connect the SERIES 21 components to other system components using system control cords.
2. Do not connect system control cords to any components other than those specified by KENWOOD. This may cause malfunction and damage your equipment.
3. Be sure the system control plugs are inserted all the way in to the system control terminals.

## About the system control operations

(Available operations when SERIES 21 components are connected through system control cords)

### Remote Control

Lets you operate source components with the system remote supplied with this unit.

### Automatic Operation

When you start playback from a source component, the input selector on this unit switches to that component automatically. (Except TAPE 2)

### Synchronized Recording

Lets you synchronize recording with the start of playback when recording from CD or LD.

## Connection of flat-cable connector

### Inserting the connector



Push in the connector straight into the socket until it clicks to indicate the locking.

### Removing the connector

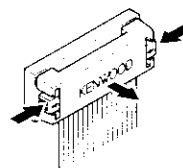

Push and hold the two ends of the connector, and pull it straight outward.



1. Connect all cords firmly. If connections are loose, there could be loss of sound or noise produced.
2. When plugging and unplugging connection cords, be sure to first remove the power cord from the AC outlet. Plugging / unplugging connection cords without removal of the power cord can cause malfunctions or damage to the unit.
3. Do not connect to a power source which is larger than that indicated on the socket at the rear of the unit.
4. If the system control cords or audio cords are not connected properly, the remote control or automatic operation between system components will not work properly.



# Connection of antenna

## Connection method to each antenna terminal

➊ Push lever.

➋ Insert cord.

➌ Return lever.

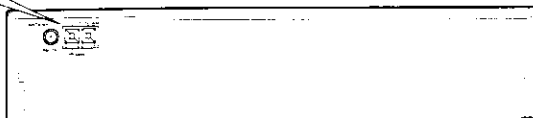

## AM loop antenna connection

The supplied antenna is for indoor use. Place it as far as possible from the main system, TV set, speaker cords and power cord, and set it to a direction which provides the best reception.

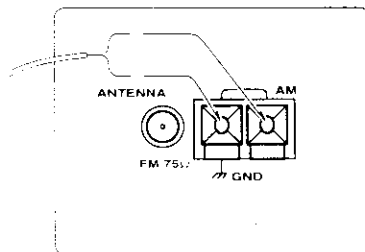
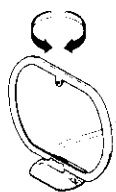

## FM indoor antenna connection

The accessory antenna is for temporary indoor use only. For stable signal reception we recommend using an outdoor antenna. Remove the indoor antenna if you connect one outdoors.

## FM outdoor antenna connection

Lead the 75 Ω coaxial cable connected to the FM outdoor antenna into the room and connect it to the FM 75 Ω terminal.

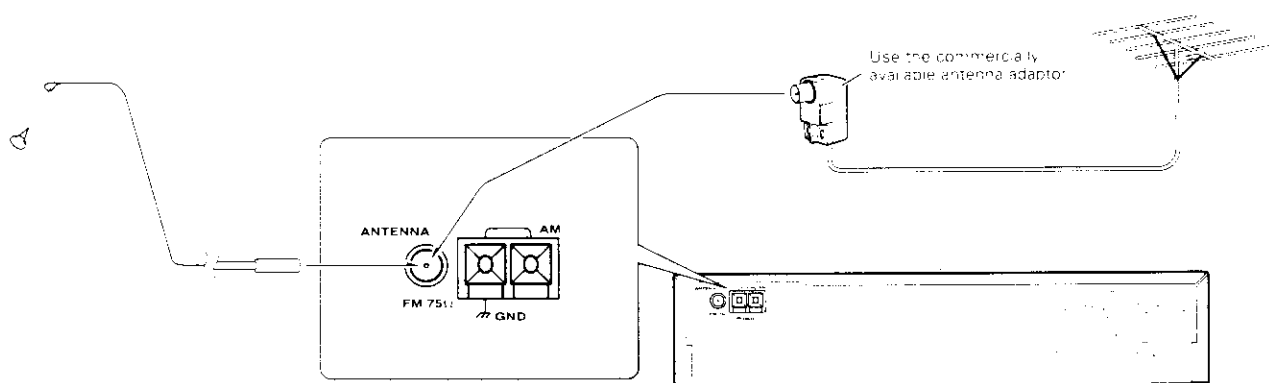

## Opening/closing the door (C-V770, C-V700)

OPEN/CLOSE



When opening or closing the door, be careful not to catch your finger in the door. Otherwise there is a risk of injury.

## Changing the input selection display (AUTO key)

\*1: To change the TAPE 1 display to MD display

- 1 Select "TAPE 1" with the INPUT SELECTOR.
- 2 Press and hold the AUTO key for more than 2 seconds, until "MD" is displayed.

Each press switches the indication.

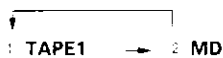

\*2: To change the DVD display to the 6ch INPUT display

- 1 Select "DVD" with the INPUT SELECTOR.
- 2 Press and hold the AUTO key for more than 2 seconds, until "6ch INPUT" is displayed.

Each press switches the indication.



To make the system control operation, the input selection display should be switched according to the actually connected components.

About the system control connections

- With the C-V770 and C-V500, the switching of \*2 is not available. The DVD is set in place.

## Switching the display mode (DISPLAY key)

Use the following procedure to change the display mode.

- 1 Press the DISPLAY key (remote control only).

Each press switches the indication.

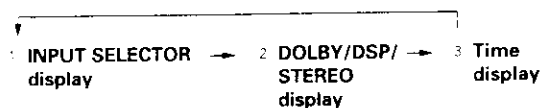

- The time display is displayed for only 5 seconds, after which the INPUT SELECTOR display appears automatically.
- The display of 2 is not shown during SOURCE DIRECT and 6ch INPUT operations.

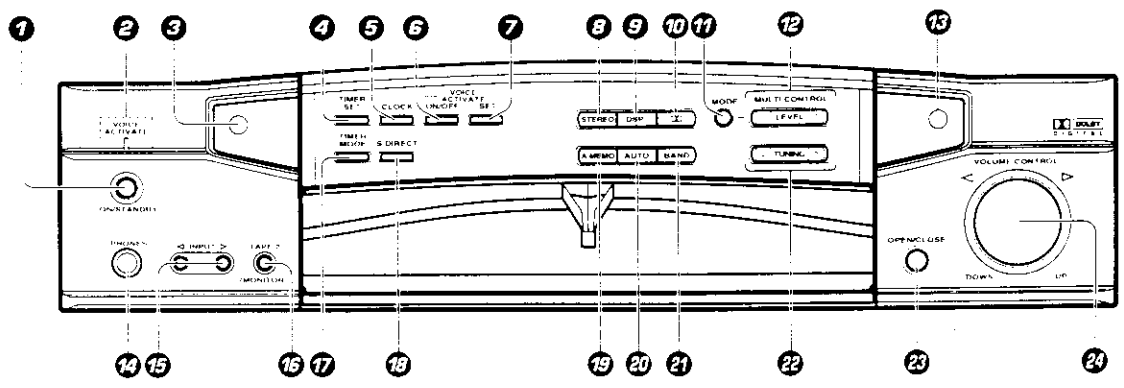
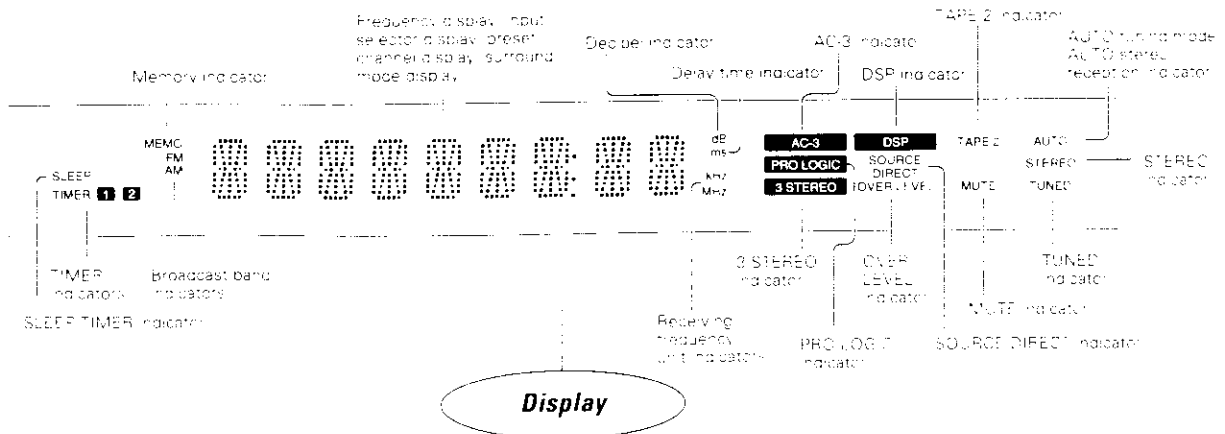

The keys which have the same names as the controls on the remote control unit provide the same functions as them.

- 1** **ON/STANDBY key**  
Press to switch between ON and STANDBY
- 2** **Indicator (C-V770)**  
**VOICE ACTIVATE indicator**  
Lights to indicate an occurrence of voice activation
- 3** **STANDBY indicator (C-V700)**  
Lights to indicate standby mode
- 4** **Remote sensor**
- 4** **TIMER SET key**  
Press to set the timer function
- 5** **CLOCK key**  
Press to set the clock.
- 6** **VOICE ACTIVATE ON/OFF key (C-V770 only)**  
Press to switch the voice-activation operation ON and OFF
- 7** **VOICE ACTIVATE SET key (C-V770 only)**  
Press to record words for use in voice activation
- 8** **STEREO key**
- 9** **DSP key**
- 10** **DOLBY key**
- 11** **MODE key**  
Press to switch various setting modes
- 12** **MULTI CONTROL keys**  
Press to select various setting modes
- 13** **GRC transmitter**  
Outputs the signals transmitted to the Graphical Remote Control
- 14** **PHONES jack**  
For use in headphones listening
- 15** **INPUT SELECTOR key**  
Press to select the input.
- 16** **TAPE 2 (MONITOR) key**  
For use in monitoring of recording, etc.
- 17** **TIMER MODE key**  
Press to switch the timer modes
- 18** **S.DIRECT key**  
Press to switch the Source Direct function which allows to reproduce the source with a better quality
- 19** **A.MEMO key**  
Press when using the auto memory function
- 20** **AUTO key**  
Press to select the tuning mode  
The auto tuning or manual tuning mode can be selected  
Pressing and holding this key for more than 2 seconds changes the TAPE 1 input display to MD display or the DVD-A input display to 6ch INPUT display
- 21** **BAND key**  
Press to switch the broadcasting band.
- 22** **TUNING keys (V, ^)**  
Press to select the radio station to be received  
These keys are also used in the clock adjustment and timer operations
- 23** **OPEN/CLOSE key**
- 24** **VOLUME CONTROL knob**

**STANDBY mode indication**

While standby mode is indicated, a small amount of power is supplied to the system to back up the memory. In this mode, the system can be turned ON by remote control.  
With the C-V770, standby mode is indicated by the display panel. The system is in standby mode when the display shows the clock display.

For C-V550, C-V500

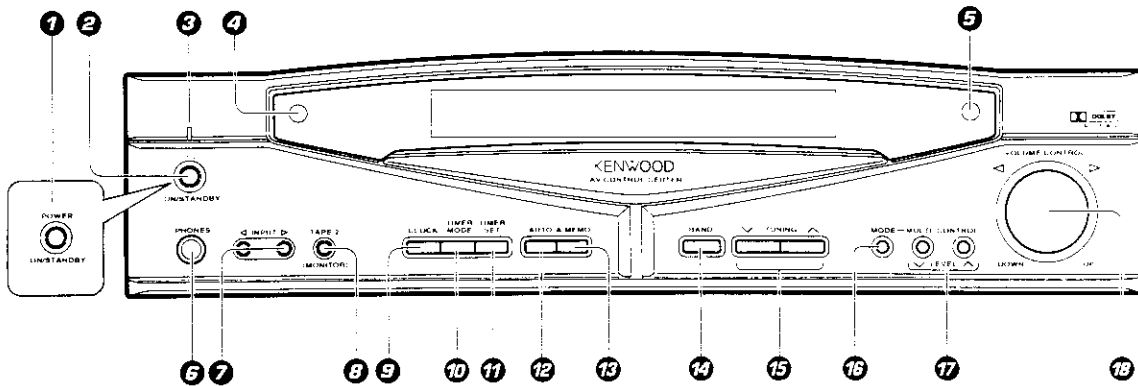
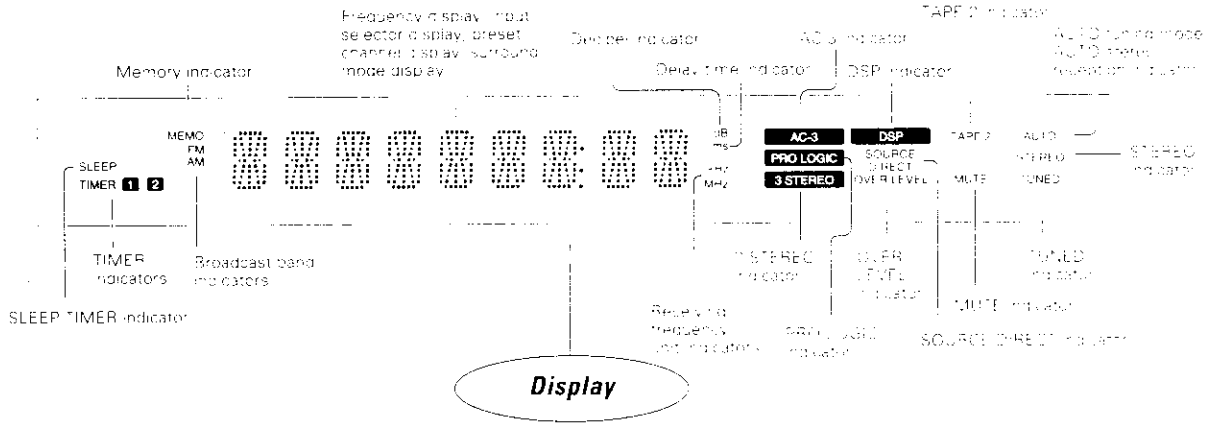

The keys which have the same names as the controls on the remote control unit provide the same functions as them.

- 1 POWER (ON/STANDBY) key (U.S.A. and Canada)**  
Press to switch between ON and STANDBY.
- 2 I/ψ (ON/STANDBY) key**  
Press to switch between ON and STANDBY.
- 3 STANDBY indicator**
- 4 Remote sensor**
- 5 GRC transmitter**  
Outputs the signal's transmitted to the Graphical Remote Control.
- 6 PHONES jack**  
For use in headphones listening.
- 7 INPUT SELECTOR key**  
Press to select the input.
- 8 TAPE 2 (MONITOR) key**  
For use in monitoring of recording, etc.
- 9 CLOCK key**  
Press to set the clock.
- 10 TIMER MODE key**  
Press to switch the timer modes.
- 11 TIMER SET key**  
Press to set the timer function.
- 12 AUTO key**  
Press to select the tuning mode. The auto tuning or manual tuning mode can be selected. The input selection display of a source can be switched to another by pressing and holding the **AUTO** key for more than 2 seconds.
- 13 A.MEMO key**  
Press when using the auto memory function.
- 14 BAND key**  
Press to switch the broadcasting band.
- 15 TUNING keys (V, ^)**  
Press to select the radio station to be received. These keys are also used in the clock adjustment and timer operations.
- 16 MODE key**  
Press to switch various setting modes.
- 17 MULTI. CONTROL keys**  
Press to select various setting modes.
- 18 VOLUME CONTROL knob**

**STANDBY mode indication**

While standby mode is indicated, a small amount of power is supplied to the system to back up the memory. In this mode, the system can be turned ON by remote control.

# Setup of the Graphical Remote Control (GRC) unit

GV770/D V700/DV550/DV590 (E1)/M

## Controls and indicators

The Graphical Remote Control (GRC) unit provided with the AV CONTROL CENTER can also control KENWOOD cassette decks, CD player and LD player which are connected to it through system control cords. For details of the controllable functions, refer to the instruction manuals of these components.

Model: GRC-100  
Infrared system



Perform "Model Type Setup" of the GRC before using it.

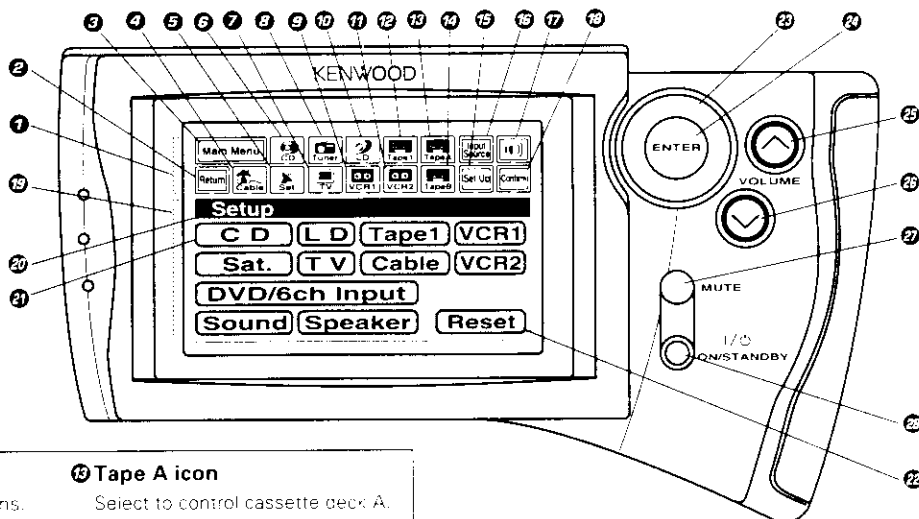

### Segment screen

#### 1 Segment screen

This area displays the fixed icons.

#### 2 Return icon

Select to return to the previous display.

#### 3 Main Menu icon

Select to change the input source or select Main Menu 2.

#### 4 Cable TV icon

Select to control the cable TV.

#### 5 Satellite Tuner icon

Select to control the satellite tuner.

#### 6 CD icon

Select to control the CD player.

#### 7 TV icon

Select to control the TV.

#### 8 Tuner icon

Select to control the tuner.

#### 9 VCR 1 icon

Select to control VCR 1.

#### 10 LD icon

Select to control the LD player.

#### 11 VCR 2 icon

Select to control VCR 2.

#### 12 Tape 1 icon

Select to control cassette deck 1.

#### 13 Tape A icon

Select to control cassette deck A.

#### 14 Tape B icon

Select to control cassette deck B.

#### 15 Set Up icon

Select to make setup operations.

#### 16 Input Source icon

Select to switch the input source.

#### 17 Sound icon

Select to control the sound-related functions.

#### 18 Confirm icon

Select to confirm a setting, etc.

- The input source can be selected using icon 3 or 16.

- Icons 4 to 14 are used to select the component to be controlled.

### Menu screen

#### 19 Menu screen

This area displays the control key icons and level information.

#### 20 Mode display

The above illustration indicates the Setup level mode.

#### 21 CD icon

Select to set up the CD player.

#### 23 Reset icon

Select to return to the "Model Type Setup" menu screen.

### Operation keys

#### 22 Joystick key

For use in selecting icons. The joystick moves in 8 directions.

#### 24 ENTER key

Press to enter a selection.

#### 25 VOLUME (UP) control key

Press to increase the volume level.

#### 26 VOLUME (DOWN) control key

Press to decrease the volume level.

#### 27 MUTE key

Press to mute sound temporarily.

#### 28 I/O (ON/STANDBY) key

Press to switch the AV CONTROL CENTER and the components connected to it through system control cords between ON and STANDBY.

## Approximate operating range

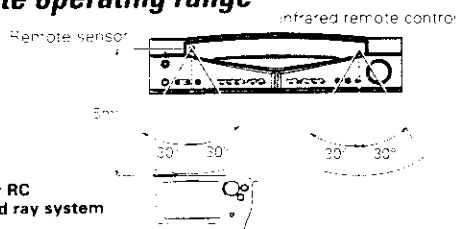

GRC or RC  
Infrared ray system



- The supplied batteries are intended for use in operation check. Therefore, their lives may be shorter than ordinary batteries.
- When the remote-controllable distance gets shorter than before, replace all four batteries with new ones.
- Malfunction may occur if direct sunlight or the light of a high-frequency lighting fluorescent lamp enters the remote sensor. In such a case, change the system installation position to prevent the malfunction.
- The GRC display may show erroneous information when the GRC unit is operated from outside the specified range.

# Setting up the GRC according to your AV CONTROL CENTER (Model Type Setup)

Perform the following procedure after inserting batteries for the first time and every time after changing them.

## Preparation

- Press the POWER or I/⏻ (ON/STANDBY) key of the main unit to the ON mode

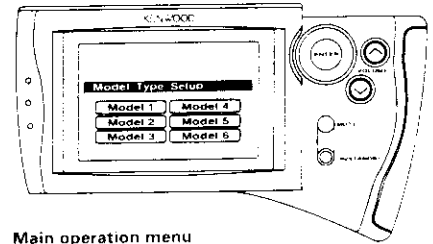

**Main operation menu**  
 (The displayed contents vary depending on the mode.)

## Model Type Setup (GRC setup procedure)

### 1 Loading batteries

- 1 Remove the cover.
- 2 Insert batteries.
- 3 Close the cover.

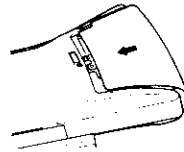
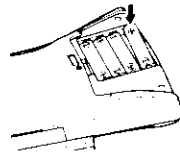
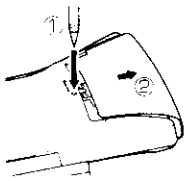

### Caution in battery replacement

- Insert four AAA-size (R03/UM-4) batteries as indicated by the polarity marking.
- To maintain the memory of the settings you made before, complete the battery replacement operation within 30 seconds.
- The procedure on the left should also be performed when resetting the GRC (as a measure against its malfunction). However, in this case, wait for about five minutes after removing the batteries and before re-inserting them.

### 2 Check the display.



The "Model Type Setup" screen appears.

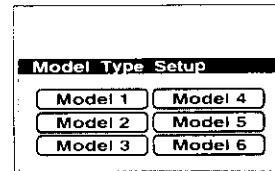

### 3 Move the cursor to the Model type icon matching the AV CONTROL CENTER.

- 1 Identify the model type.  
 (Use the table on the right.)
- 2 Move the cursor.



It can be moved in 8 directions depending on how you press the joystick key.

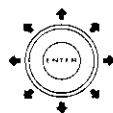

The icon on which the cursor is moved blinks in reverse video.

AV CONTROL CENTER Model	GRC "Model Type Setup" icon
C-V100 .....	Model 1
C-V150 .....	Model 1
C-V300 .....	Model 2
C-V350 .....	Model 2
C-V500 .....	Model 3
C-V550 .....	Model 4
C-V700 .....	Model 4
C-V750 .....	Model 4
C-V770 .....	Model 3

### 4 Enter the selection.

Press the ENTER key.



ENTER

### To change Model Type Setup

- 1 Select Set Up.
- 2 Press the ENTER key.
- 3 Select Reset.
- 4 Press the ENTER key.
- 5 Perform the setup procedure from step "2 Check the display".

● The above operation clears all of the previously made settings and returns the GRC to the initial condition.

# Setting up the GRC according to the option components (Set Up)

The following procedures prepare the GRC for operating the components connected through system control cords. Make sure that these components are connected through system control cords.

- If you proceed to the following "Set Up" operations immediately after steps 1 to 4 of "Model Type Setup (GRC setup procedure)" on page 16, start operation with step 5. Select the CD icon in the "Set Up CD" procedure.

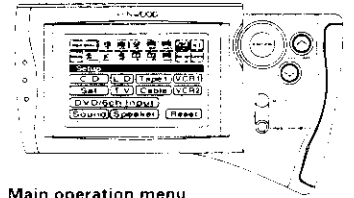

**Main operation menu**  
The displayed icons are varied depending on the model.

## Set Up CD

Setup of GRC according to the CD player in use

## Set Up Tape 1

Setup of GRC according to the cassette deck in use

## Set Up LD

Setup of GRC according to the LD player in use

- 1 Select the "Set Up" icon.
- 2 Press the "ENTER" key to enter the selection.
- 3 Select the "CD" icon.
- 4 Press the "ENTER" key to enter the selection.
- 5 Select the "Single" icon.
- Select "Single", "Dual", "Carrouse" or "Changer" according to the connected CD player type.
- 6 Press the "ENTER" key to enter the selection.
- 7 Select the "Main Menu" icon.
- 8 Press the "ENTER" key to enter the selection.

- 1 Select the "Set Up" icon.
- 2 Press the "ENTER" key to enter the selection.
- 3 Select the "Tape 1" icon.
- 4 Press the "ENTER" key to enter the selection.
- 5 Select the "Dual" icon.
- Select "Dual" or "Single" according to the connected cassette deck type.
- 6 Press the "ENTER" key to enter the selection.
- 7 Select the "Main Menu" icon.
- 8 Press the "ENTER" key to enter the selection.

- 1 Select the "Set Up" icon.
- 2 Press the "ENTER" key to enter the selection.
- 3 Select the "LD" icon.
- 4 Press the "ENTER" key to enter the selection.
- 5 Select the "System Control" icon.
- Select "System Control" or "IR" according to the connected LD player type.
- 6 Press the "ENTER" key to enter the selection.

• Icon appears at the moment the setup has completed.

• Icons / or icon appear at the moment the setup has completed.

• Icon appears at the moment the setup has completed.

In the operations of the GRC (Graphical Remote Control unit), proceed to each step within 10 seconds after the previous step.  
The display disappears in 10 seconds:



To resume GRC display, move the Joystick key in any directions

# Setting up the GRC according to other components (Set Up)

The GRC can also be used to remote control other components which are not connected through system control cords. To control another component, it is required to register the setup code corresponding to it beforehand. — 51

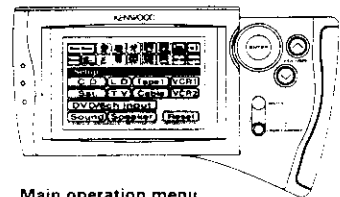



Main operation menu  
The displayed icons are variable depending on the mode.

## Registering setup codes for VCR 1

**1** Find the setup code of the component to be registered by referring to the Setup code chart in this manual.

**2** Enter the setup code.



① Select the "Set Up" icon. 

② Enter the selection by pressing the "ENTER" key. 

③ Select the "VCR 1" icon. 

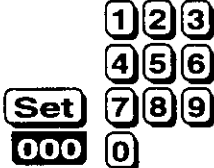
④ Enter the selection by pressing the "ENTER" key. 

⑤ Enter the setup code. 

⑥ Select the "Set" icon.   

⑦ Enter the selection by pressing the "ENTER" key. 

### Check the operation of the component.

- ① Display the operation screen of the component to be checked.
- ② Turn on the component from the GRC and confirm the actual component.
- If there is more than one setup code, input each code to see which one turns the power on. That will be the correct code for your component.



Although each setup code is designed to work with a number of different models, certain codes may not work with some models. (Also, certain codes may only operate some of the functions available on a given model.) With some models, be sure to keep the ENTER key pressed for a while.

Use the numeric keys as shown below.

Entry examples:

431 .....      

400 .....      

- When a code which is not shown in the setup code chart is entered, the entered code disappears automatically.

## Registering setup codes of other components

The procedure of steps **1** and **2-①** to **⑦** of "Registering setup code for VCR 1" also allows to register the components listed below to remote control them from the GRC.

**Registering setup code for VCR 2**

**Registering setup code for TV**

**Registering setup code for CABLE**

**Registering setup code for SATELLITE**

**Registering setup code for LD player (IR)**



# Remote control of components from the GRC

CV770/0-V790/0-V850/0-V900 (E4/M)

## Controlling the AV CONTROL CENTER

The operations required to remote control the AV CONTROL CENTER includes the INPUT SELECTOR selection, display mode selection, stereo selection and so on. The following procedures show how to remote control the basic operations of the GRC.

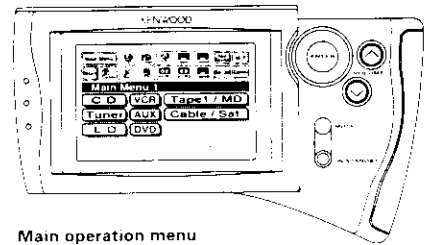

Main operation menu  
The displayed items are not limited to those of the model.

## Operation examples

### Switching the INPUT SELECTOR (Selecting the CD input)

### Switching the display mode of the AV CONTROL CENTER

### Selecting the stereo mode

- 1 Select the "Main Menu" icon in the fixed segment screen by operating the joystick.



- 2 Press the "ENTER" key to enter the selection.



- 3 Select the "CD" icon with the joystick.



- 4 Press the "ENTER" key to enter the selection.



- 5 The input source is switched to "CD".

- Other input than CD can be selected in step 3.

- 1 Select the "Main Menu" icon in the fixed segment screen by operating the joystick.



- 2 Press the "ENTER" key to enter the selection.



- 3 Select the "Main Menu" icon again.



- 4 Press the "ENTER" key to enter the selection.



- 5 Select the "Display" icon.

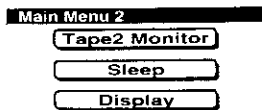

- 6 Press the "ENTER" key to enter the selection.



- 7 Each press of the "ENTER" key switches the display mode.

- It is also possible to select the Tape 2 Monitor or Sleep icon in step 5.

- 1 Select the "Sound" icon in the fixed segment screen by operating the joystick.



- 2 Press the "ENTER" key to enter the selection.



- 3 Select the "STEREO" icon with the joystick.



- 4 Press the "ENTER" key to enter the selection.



- It is also possible to select the Pro Logic, 3 STEREO or Source Direct icon in step 3.

# Controlling the components connected through system control cords

When a CD player, cassette deck and/or LD player are connected with the AV CONTROL CENTER through system control cords, their system control operations are possible from the GRC.

## Preparations

- System control connection → 8
- Model Type Setup → 15
- Setup of source components → 16

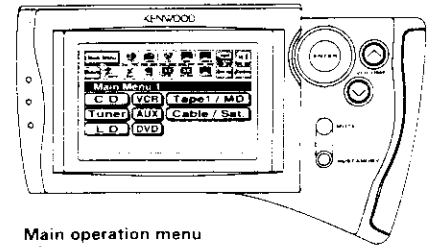

**Main operation menu**

The displayed icons are variable depending on the mode.

## Operating the tuner

- 1 Select the "Tuner" input.

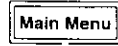

ENTER



ENTER

- 2 Display the tuner operation menu.



ENTER

- 3 Select the icon to be operated.

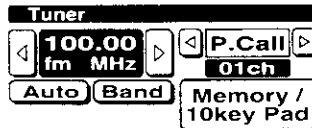

- 4 Enter the selection  
by pressing the "ENTER"  
key.

ENTER

- After selecting the icon, press the "ENTER" key to enter the selection

- Any of the keys which can control the tuner can be selected

## Operating the CD player

- 1 Select the "CD" input.

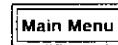

ENTER



ENTER

- 2 Display the CD operation menu.



ENTER

- 3 Select the icon to be operated.



- 4 Enter the selection  
by pressing the "ENTER"  
key.

ENTER

- Any of the CD player operation keys can be selected
- The menu display shown on the left is an example which appears with a single CD player.

- For the operation of the CD player, also read the instruction manual of the CD player.

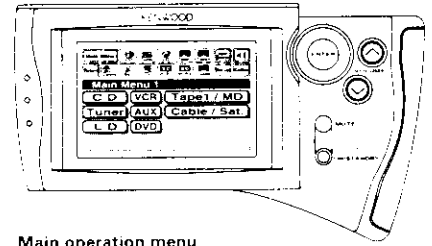

**Main operation menu**  
 (The displayed icons are varied according to the model.)

## Operating the cassette deck

- ❶ Select the "Tape 1" input.
- ❷ Display the cassette deck operation menu.
- ❸ Select the icon to be operated.
- ❹ Enter the selection (by pressing the "ENTER" key).

- The procedure on the left is an example assuming that "Dual" has been selected in the "Setup" operation.
- In case "Single" was selected in the Setup operation, the "Tape 1" icon is displayed.

- Any of the cassette deck operation keys can be selected.

- For the operation of the cassette deck, also read the instruction manual of the cassette deck.

## Operating the LD player

- ❶ Select the "LD" input.
- ❷ Display the LD player operation menu.
- ❸ Select the icon to be operated.
- ❹ Enter the selection (by pressing the "ENTER" key).

- Any of the LD player operation keys can be selected.
- The procedure on the left is an example assuming that "System Control" has been selected in the "Setup" operation.

- For the operation of the LD player, also read the instruction manual of the LD player.

## One-touch operation and easy operation features

### (CD player, cassette deck and LD player)

When the system is in standby mode, the operations as described below are possible provided that the associated components are connected through system control cords.

#### Preparations

- 1 Ensure that system control cords are connected.
- 2 Set the power switch of the cassette deck and LD player to the ON position.
- 3 Set the power switch of the power amplifier to the ON position.
- 4 Load the source component with the software to be played.
- 5 Press the POWER or I/O key of the AV CONTROL CENTER to put it to standby mode.

- Use the main unit keys for operation.

- The clock information is displayed in standby mode. (C-V770)
- The STANDBY indicator lights. (C-V700/C-V550/C-V500)

#### Function available with the play key operation

- 1 Press the play key.
- 2 The system is switched from standby mode to ON mode.
- 3 The input selector is switched automatically.
- 4 Playback starts.

- CD player and cassette deck

#### Function available with the eject key operation

- 1 Press the eject key.
- 2 The system is switched from standby mode to ON mode.
- 3 The tray panel of the source component opens.

- CD player and cassette deck

- This operation is not available from the eject key of a double cassette deck.

#### Operation available by switching the input selector

- 1 Select the desired input with the input selector.
- 2 The selected source component starts to play.

- Turn on the system before switching the input selector.

- This operation is available when the CD, TAPE 1 or LD input is selected.

# System component startup by voice activation (C-V770 only)

C-V770/C-V700/C-V550/C-V500 (E) (M)

When the VOICE ACTIVATE ON/OFF key is set to ON, talking a previously recorded word into the exclusive microphone switches the system components from standby mode to ON mode.

The voice activation can use either the preset word ("KENWOOD") (spoken by any person) or the desired words recorded by the user (spoken by a specific person(s)).



If the system is not activated properly by your pronunciation or "KENWOOD", it is recommended to record your own words and use them for the voice activation (specific person). — 23

## Starting the system components by voice activation (by any person)

### Preparation for voice activation (when the system is to be activated by speaking "KENWOOD")

#### Main unit

- 1 Ensure that the exclusive microphone is connected.
- 2 Press the POWER or I/⏻ (ON/STANDBY) key to ON mode.



- 3 Press the OPEN/CLOSE key to open the door.
- 4 Press the VOICE ACTIVATE ON/OFF key to ON (so that the indicator lights in red).



Lights in red



- 5 Press the OPEN/CLOSE key to close the door.
- 6 Press the POWER or I/⏻ (ON/STANDBY) key to STANDBY mode (so that the display shows the clock information).

- Load the CD player or LD player with the software to be played.

Each press switches the function as follows.

- 1 When the indicator is lit:  
..... VOICE ACTIVATE is ON.
- 2 When the indicator is not lit:  
..... VOICE ACTIVATE is OFF.

### Operation for voice activation of system components (by any person)

- 1 Speak "KENWOOD" into the exclusive microphone.
- 2 The system components are switched from standby mode to ON mode. The input selection is switched to CD or LD, and the corresponding component starts playback.

- The voice is recognized by word "KENWOOD" spoken by any person.
- If both the CD player and LD player have been connected, the CD player is given the precedence.

## Auto power-save

When the system has been started up by voice activation, it will return to standby mode by automatically taking the following steps.

- 1 The system components are started up by voice activation.
- 2 CD or LD starts to be played.
- 3 After the CD or LD playback completed, the system has remained in stop mode for about 30 minutes.
- 4 The system returns automatically to standby mode.

- The CD player or LD player should be loaded with the software to be played before the voice activation.
- If none of the CD player or LD player has been loaded with software, the system remains in stop mode for about 30 minutes then returns automatically to standby mode.
- If the input source is changed during playback of the CD or LD player after the system has been started up by voice activation, the auto power-save function is released.

The voice activation setting function allows the user to record desired words for use in voice activation. The user can switch the system from standby mode to ON mode by speaking the recorded words. However, note that voice activation using preset "KENWOOD" is not possible when the user's words are recorded for voice activation.

#### Note for voice activation recording

The words for use in voice activation should be recorded in an quiet environment. Correct recording may sometimes be impossible in a noisy environment. When using the voice activation function, too, adjust the microphone position so that it does not pick up noise.

## Recording the user's own voice for voice activation (by specific person)

One as well as more than one word can be recorded for use in voice activation.

**Main unit**

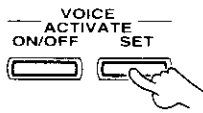
- Press the VOICE ACTIVATE SET key to ON.
 
- The indicator lights in amber.
 

(Record-ready mode)

Lights in amber

- Record voice (words).
 

(The indicator goes out during recording.)

Speak desired words into the exclusive microphone in less than 2 seconds.

Goes out

- Repeat steps 2 and 3 until "RECORD OK" is displayed.
 

(Repeat 3 times or more.)
- Now the recording is completed.
 

(The indicator lights in green.)

Lights in green



- Up to 5 words can be recorded provided that they are spoken in less than about 12 seconds. If a long word is recorded, the total number of words which can be recorded may become less than 5.
- Either one user can record up to 5 words or up to 5 users can record one word per person.
- If more than the specified number of words are recorded, the words recorded earlier are overwritten by newly recorded words in the order they were recorded.
- "RECORD" is displayed to indicate the status in which voice recording is possible. "RECORD OK" is displayed when recording has completed successfully.
- Repeat steps 1 to 5 if you want to record another word.

- If recording failed, the display lights in red and shows "RECORD NG". In this case, restart the procedure from step 1.

### To erase the recorded voice

**Main unit**

- Press and hold the VOICE ACTIVATE SET key for more than 5 seconds.
- The entire recorded voice is erased.

- When the recorded words are erased, the unit returns to the status which allows "Starting the system components by voice activation (by any person)" specified by "KENWOOD".

## Starting the system by voice activation using the recorded words (by specific person)

### Preparation for voice activation operation

**Main unit**

- Ensure that the exclusive microphone is connected.
 

→ 5
- Press the POWER or I/⏻ (ON/STANDBY) key to ON mode.
- Press the OPEN/CLOSE key to open the door.
- Press the VOICE ACTIVATE ON/OFF key to ON.
 

(so that the indicator lights in green.)

Lights in green

- Close the door.
- Press the POWER or I/⏻ (ON/STANDBY) key to STANDBY mode.
 

(so that the display shows the clock information.)

- Load the CD player or LD player with the software to be played.
- If the indicator lights in red, the unit is in the status which allows "Starting the system components by voice activation (by any person)".

### Operation for voice activation of system components (by specific person)

**Main unit**

- Speak the recorded words into the exclusive microphone.
- The system components are switched from standby mode to ON mode. The input selection is switched to CD or LD, and the corresponding component starts playback.

- If both the CD player and LD player have been connected, the CD player is given the precedence.
- The auto power-save operation also occurs after the system components are turned ON by means of voice activation by specific person.

# Playing music

CV770/CV700/CV550/CV500 (E/F/M)

The following procedure allows to play a CD or cassette tape.

## Preparations

- Connect components as described in "System connection" - 5
- Complete "Setup of the Graphical Remote Control (GRC) unit" - 14

### 1 Press the ON/STANDBY key to ON.

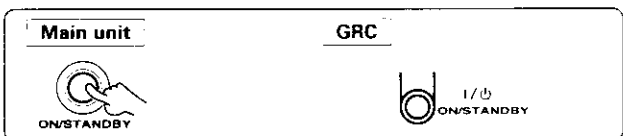

### 2 Select the input source.

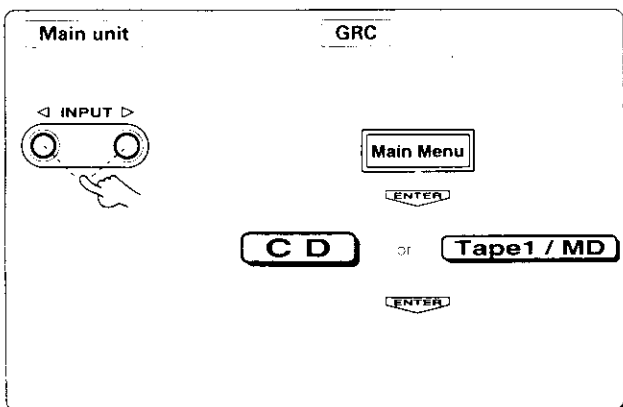

### 3 Play the selected source.

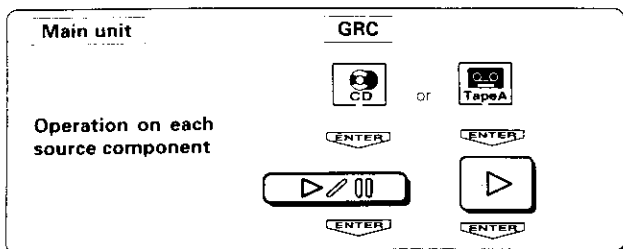

### 4 Adjust the volume.

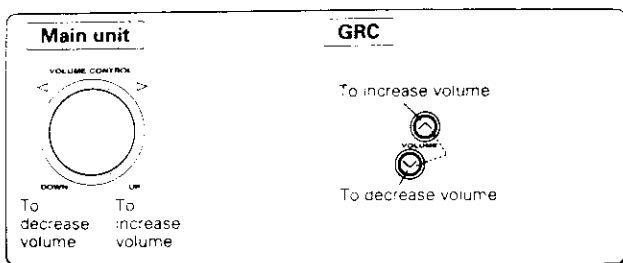

- Load the CD player or cassette deck with the software to be played  
→ Read the instruction manuals of the associated components

With the main unit operation, the input sources are switched as shown below.

- 1 VCR
- 2 AUX
- 3 TAPE 1 / MD \*1
- 4 TUNER (frequency display)
- 5 CD
- 6 DVD-D
- 7 DVD-A / 6ch INPUT \*2
- 8 LD -D
- 9 LD -A
- 10 CABLE / SAT

The selected source is displayed



- \*1: To change the TAPE 1 display to MD display
- \*2: To change the DVD-A display to the 6ch INPUT display

To enable system-control operation, the displayed information should be set according to the actually connected components. - 10

- Note for using the 6ch INPUT - 27
- Step 2 can be omitted if the easy operation feature is available. - 21



#### One-touch operation

Pressing the play key of the CD player or cassette deck starts up the system automatically and starts playback. When this operation is used, steps 1 and 2 can be omitted. - 21

Volume level is displayed

VOLUME - 50 <sup>dB</sup>

- The time taken till the volume level is displayed is variable depending on the current operating condition.
- Rotating the **VOLUME CONTROL** at a higher speed increases the amount of volume change (AI VOLUME function).
- The sound of input source cannot be listened to while **TAPE 2 (MONITOR)** is ON.

## Adjusting the tone

**Main unit**



IC-V700/C-V770 only

**GRC**

1 Select STEREO.



2 Select the BASS or TREBLE adjustment.



3 Adjust the selected item.



Press MULTI. CONTROL LEVEL Up or Down key

To decrease level      To increase level

**Main unit**

Each press of the **MODE** key switches the adjustment item as shown below.

1	<b>BASS</b>	Tone, Bass
2	<b>TREBLE</b>	Tone, Treble
3	<b>L ----- R</b>	Balance
4	<b>SW ch</b>	Subwoofer
5	<b>INPUT</b>	Input level

**GRC**

The adjustment menu appears

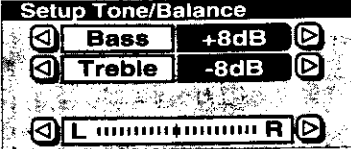

- The display on the GRC disappears if no operation has been performed for about 10 seconds
- The display on the main unit disappears if no operation has been performed for about 5 seconds



Display when BASS is selected      The level value changes

- The level can be adjusted between -8 and +8 in steps of 2
- The tone cannot be adjusted when the input selector is set to 6ch INPUT or the AC-3 indicator is displayed.

## Adjusting the left/right sound balance

**Main unit**



IC-V700/C-V770 only

**GRC**

1 Select STEREO.



2 Select the Balance adjustment.

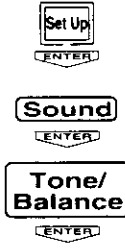

3 Adjust the selected item.

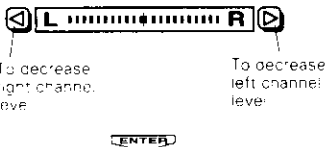

Press MULTI. CONTROL LEVEL Up or Down key

To decrease right channel level      To decrease left channel level

**Main unit**

Each press of the **MODE** key switches the adjustment item as shown below.

1	<b>BASS</b>	Tone, Bass
2	<b>TREBLE</b>	Tone, Treble
3	<b>L ----- R</b>	Balance
4	<b>SW ch</b>	Subwoofer
5	<b>INPUT</b>	Input level

- GRC**
- If you proceed to this procedure immediately after that for "Adjusting the tone", you can use the same menu on the GRC.

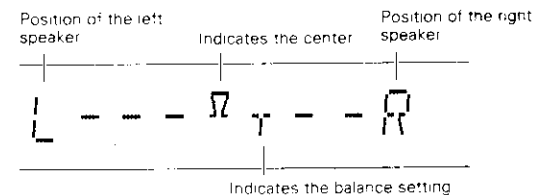



## Source Direct playback

This feature allows you to play the source signal with a high quality by passing it only through the minimum required circuitry.

Main unit

GRC

**1 Select the playback source.**

Main Menu

ENTER

C D

ENTER

**2 Select SOURCE DIRECT.**

S.DIRECT

(C-V700/C-V770 only)

⏮

ENTER

Source Direct

ENTER

**3 Playback the source.**

Lights up



- During Source Direct playback, the tone controls (BASS and TREBLE) and balance control are defeated.
- The Source Direct playback is canceled when any key associated with the surround play is pressed.
- The Source Direct playback is not possible when the input selector is set to 6ch INPUT or during Dolby Digital playback.

### To cancel

Select the Source Direct (S.DIRECT) again.

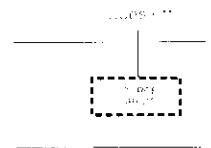

## To listen through headphones

**1 Plug headphones.**

**2 Adjust the volume.**

Main unit

GRC

To decrease volume

To increase volume

To increase volume

VOLUME

To decrease volume

- The speaker sound is defeated at the moment headphones are inserted into the **PHONES** jack.
- If headphones are plugged in during surround play, its mode is automatically switched to the STEREO mode. If they are plugged in during 6ch INPUT play, only the front Lch and Rch will be played. The previous status resumes at the moment headphones are unplugged.
- If headphones are plugged in during test tone output, the test tone output stops.

## To mute sound temporarily

GRC



Blinks

### To cancel

Press the MUTE key again.

When recording sound with a recorder component of KENWOOD, synchro recording is possible by setting the INPUT SELECTOR to select TAPE1 or MD according to the connected component.

## To record a music source

**Main unit**

◀ INPUT ▶

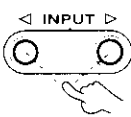

**GRC**

① Select the source to be recorded.

Main Menu

ENTER

Select an input source other than TAPE 1.

Main Menu 1

C D	VCR	Tape1 / MD
Tuner	AUX	Cable / Sat.
LD	DVD	

ENTER

② Put the cassette deck in record-pause mode.

③ Play the source and start recording.

**Main unit**

Each press switches the indication

- 1 VCR
- 2 AUX
- 3 TAPE 1 / MD
- 4 TUNER (frequency display)
- 5 CD
- 6 DVD-D
- 7 DVD-A / 6ch INPUT
- 8 LD -D
- 9 LD -A
- 10 CABLE / SAT

**GRC**

Select the icon of the source to be played.

- The TAPE 1 display can be changed to the MD display and the DVD display can be changed to the 6ch INPUT display. — 10
- For the recording using a cassette deck or MD recorder, read the instruction manual of the cassette deck or MD recorder.
- Recording sound from a MD recorder onto TAPE 1 is not possible because the input selection is overlapped.
- Remember that varying the input level during recording causes the recording level to be varied

## Notes for using the LD, DVD or 6ch INPUT source

When LD, DVD or 6ch INPUT is selected as the input source, the operation is subjected to the following restrictions

### Restrictions with LD and DVD:

- 1 Both audio and video can be recorded if the source uses analog audio
- 2 Audio recording is not available if the source uses digital audio. However, audio recording is possible if the analog input from the source is available (when the analog output jacks of the DVD are connected to the FRONT audio input jacks of the AV CONTROL CENTER and the DVD outputs analog audio signal).
- 3 The TAPE 2 (MONITOR) function is not available with the digital input.

### Restrictions with 6ch INPUT:

- 1 The played audio cannot be recorded
- 2 The monitor function cannot be activated by pressing the TAPE 2 (MONITOR) key
- 3 Surround play, its adjustment, STEREO mode play, tone adjustment and Source Direct play are not available

## Regarding TAPE 2 (MONITOR)

A cassette deck or graphic equalizer can be connected to this unit's TAPE 2 (MONITOR) terminals. If you connect a graphic equalizer, turn the TAPE 2 (MONITOR) key ON. If you connect a 3-head cassette deck, you can monitor the source sound, or the sound being recorded, while recording. Pressing the TAPE 2 (MONITOR) key lets you compare the recorded sound and the source sound. Refer to the operating manual for the component you connected for further details.

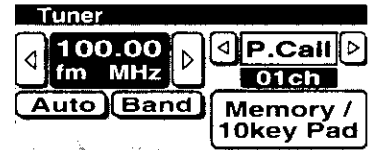

### Main operation menu

(The displayed icons are variable depending on the model.)

## Receiving broadcast station

### 1 Select the TUNER input.

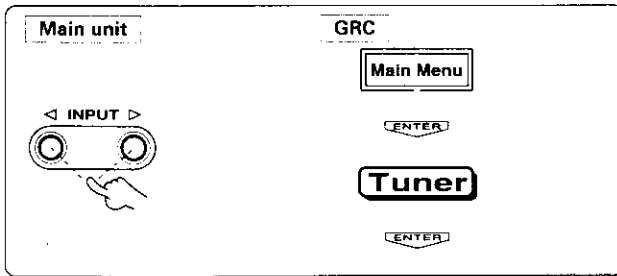

### Main unit

Each press switches the indication.

- 1 VCR
- 2 AUX
- 3 TAPE 1 / MD
- 4 TUNER (frequency display)
- 5 CD
- 6 DVD-D
- 7 DVD-A / 6ch INPUT
- 8 LD-D
- 9 LD-A
- 10 CABLE / SAT

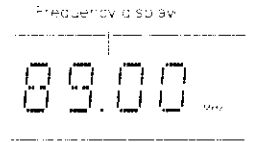

### 2 Select the broadcast band.

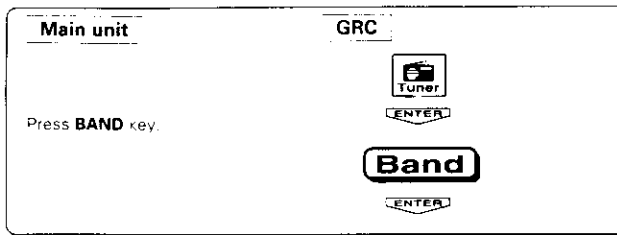

Each press switches the indication.

- 1 FM
- 2 AM

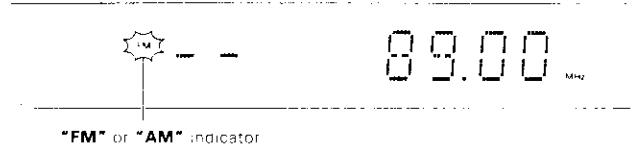

- You can also start the procedure from step 2 by omitting step 1.

### 3 Select the tuning method.

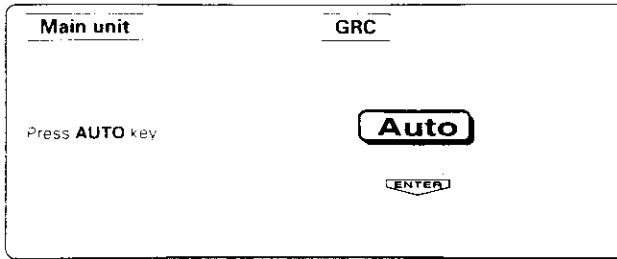

Each press switches the indication.

- 1 AUTO lit (auto tuning)
- 2 AUTO not lit (manual tuning)

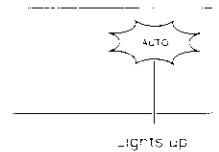

- Usually, set the switch to **AUTO** (auto tuning).

Select manual tuning when noise interferes due to weak radio wave. (The stereo broadcasting is received in monaural during manual tuning.)

### 4 Select a station.

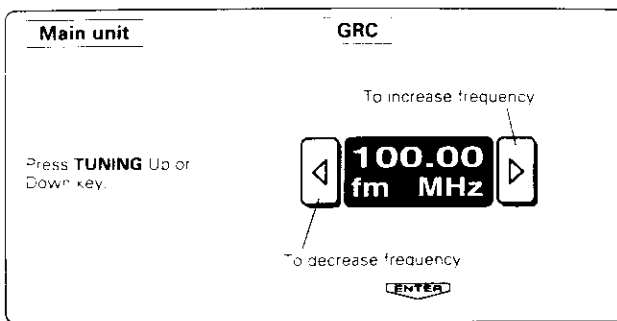

Frequency display

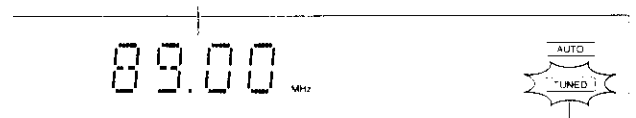

"TUNED" lights up when a station is tuned.

- Auto tuning : The next station found is tuned automatically.
- Manual tuning : Press repeatedly or hold until a station is tuned.

Use the operating procedure on this page to store stations automatically in preset memory. Up to 40 stations can be preset and received with a simple key operation.

## Storing stations automatically in preset memory (AUTO MEMORY)

The following procedure allows to select broadcast stations and store them in the preset memory (up to 40 stations can be preset).

### 1 Set the INPUT SELECTOR to "TUNER".



### 2 Set the receiving band.



### 3 Preset radio stations by AUTO MEMORY.

**Main unit**

The stations which are received are stored in order beginning from preset channels "01" (up to 40 stations can be preset).

Press A MEMO key.

When the receiving band selected in step 2 include no more than 40 stations, stations in other bands than it will be preset after them.

## Receiving a preset station

**GRC**

Enter the preset number (max. 40) of the desired station.

1 2 3  
4 5 6  
7 8 9  
0 +10

#### Main unit

Each press switches the indication.

- 1 VCR
- 2 AUX
- 3 TAPE 1 / MD
- 4 TUNER (frequency display)
- 5 CD
- 6 DVD-D
- 7 DVD-A / 6ch INPUT
- 8 LD -D
- 9 LD -A
- 10 CABLE / SAT

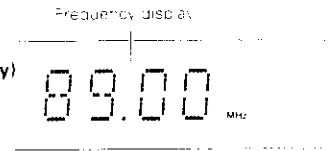

- The previously tuned frequency is displayed

Each press switches the indication.

- 1 FM
- 2 AM

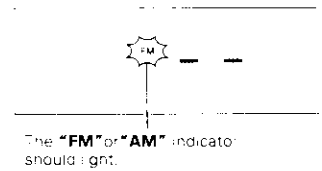

Blinks



- The channels preset by the Auto Memory operation are stored by replacing the same number of previously preset channels as the newly preset channels

Press numeric keys in the order as described below:

To enter "15" ..... **+10** **ENTER** **5** **ENTER**

To enter "20" ..... **+10** **ENTER** **+10** **ENTER** **0** **ENTER**

- If you commit a mistake in entering the digit of 10, press the **+10** key several times to return to the original display and re-enter the preset number from the beginning



The AUTO MEMORY function stores radio stations starting with preset channels number 1 by giving priority to the stations of the band being selected. In consequence, if you want to preset the stations in other bands than the selected band, first execute the AUTO MEMORY operation then preset other desired stations manually in preset channels left idle after the stations preset by Auto Memory.

### Preparation

- Select the TUNER input. — 19
- Display the Tuner operation menu. — 19

### Order of radio station presetting



The manually preset stations can be preset either after the stations preset by the AUTO MEMORY function as shown below or by overwriting them.

Preset number  
1 2

39 40

Station preset with  
AUTO MEMORY



Station preset with  
Manual Memory

## Storing radio stations manually in preset memory

### GRC

- 1 Select the receiving band.
- 2 Select a station or frequency.
- 3 Press the Memory key during receiving a station.



Proceed to step 4 within 10 sec.  
(If more than 10 sec. have elapsed,  
press the Memory key again.)

Memory /  
10key Pad

ENTER

Memory

ENTER

- 4 Select one of the preset numbers from 1 to 40.

1 2 3  
4 5 6  
7 8 9  
0 +10

ENTER

- Apart from the auto memory function, stations can also be stored manually in the preset memory.
- In the manual memory storage operation of radio stations, it may take a few minutes after the Memory key is pressed till the memory display starts to blink depending on the receiving condition.

Lights up for 10 sec.    Blinks for 10 sec.

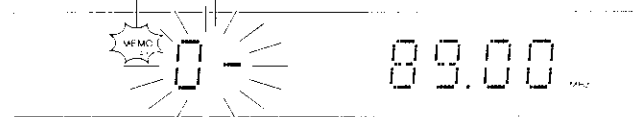

Press the numeric keys in the following order

To store in "15" ... **+10** **ENTER** **5** **ENTER**  
To store in "20" ... **+10** **ENTER** **+10** **ENTER** **0** **ENTER**

- Repeat steps 1, 2, 3, 4 for each of the stations to be stored in memory.
- If a station is stored in a preset number which has already stored a station memory under it, the previous memory is replaced by the new memory content.

## Receiving a preset station

### GRC

Memory /  
10key Pad

ENTER

1 2 3  
4 5 6  
7 8 9  
0 +10

ENTER

Enter the preset number (max.  
40) of the desired station.

Press the numeric keys in the following order

To recall "15" ..... **+10** **ENTER** **5** **ENTER**  
To recall "20" ..... **+10** **ENTER** **+10** **ENTER** **0**

- If you make a mistake in entering the figure of 10, press the +10 key repeatedly until the original display is shown, then enter the correct number.

Preset number stored in memory



## Receiving all preset stations in order (P. CALL)

### GRC

The preset number  
decreases.

The preset number  
increases.

◀ **P.Call** ▶  
**01ch**

ENTER

- Every time the key is pressed, the next station in the order of the preset number is received.

When you press **P.Call** key, .....

1 → 2 → 3 ..... 38 → 39 → 40

When you press ◀ **P.Call** key, .....

1 ← 2 ← 3 ..... 38 ← 39 ← 40

If the key is held pressed ..... Preset stations will be received successively for about half a second each.

This AV CONTROL CENTER incorporates 4 different sound modes to let you enjoy surround sound with a wide variety of program sources. The Dolby Digital (AC-3) and Dolby Pro Logic surround sound let you enjoy theater-like surround effects when you play Dolby Digital (AC-3) and Dolby Surround program sources (like Laserdiscs and DVDs). Dolby 3 Stereo creates a panoramic frontal sound field. The Digital Signal Processing (DSP) modes let you create a variety of different sonic environments from almost any type of program source.

To obtain the best possible surround sound, be sure to complete "Setup for surround play" before using the surround modes.

- 34

## Sound modes

### Dolby Digital (AC-3)

The Dolby Digital (AC-3) surround format lets you enjoy up to 5.1 channels of digital surround sound from Dolby Digital (AC-3) program sources (such as Laserdisc software marked ). Compared with previous Dolby surround, Dolby Digital (AC-3) provides even better sound quality, greater spatial accuracy, and improved dynamic range.

#### Note

Although a full set of speakers (front left, right, and center, Surround left and right, and a subwoofer) is required for true 5.1 channel Dolby Digital (AC-3) surround sound, this AV CONTROL CENTER lets you enjoy Dolby Digital (AC-3) (and Dolby Pro Logic) program sources, even if you connect only the front speakers.

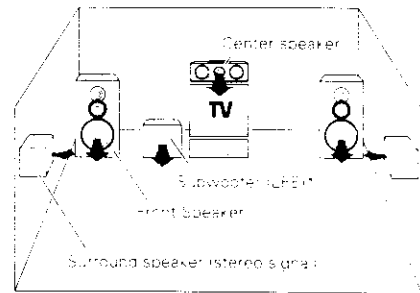

\* LFE = Low Frequency Effects. This channel delivers separate non-directional bass signals to the subwoofer for more dynamic deep bass sound effects.

Although only Dolby Digital (AC-3) soundtracks incorporate a separate low frequency channel, connecting a subwoofer will also improve deep bass performance in the other surround modes.

### Dolby Pro Logic

Dolby Pro Logic is a specially encoded 2 channel surround format designed to provide theater-like surround sound from Dolby Surround encoded sources (such as video and Laserdisc software marked ). This AV CONTROL CENTER is equipped with a Dolby Pro Logic surround decoder to let you enjoy the wide variety of currently available Dolby Surround home video software.

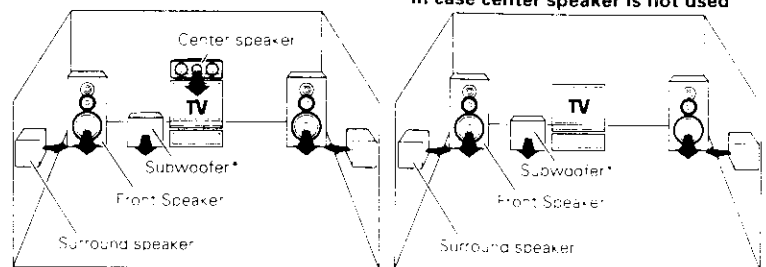

\* Optional in this mode.

### Dolby 3 Stereo

Dolby 3 Stereo is available for systems that do not have surround speakers. When in the Dolby 3 Stereo mode the surround information is redirected to the front left and right speakers. This mode is designed for use with Dolby Surround program sources, but can also improve sound field unity for programs that are not Dolby Surround encoded. Dialog positioning and sound image definition, however, may not be as accurate when used with programs that are not Dolby Surround encoded.

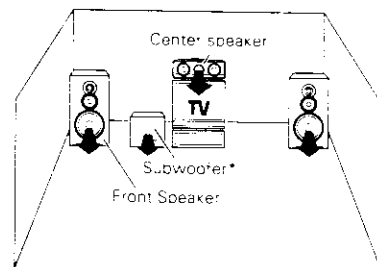

\* Optional in this mode.

## DSP mode

The DSP mode lets you add the atmosphere of an arena, jazz club, or stadium to almost any type of program source.\* These modes are particularly effective when used with stereo program sources, like CD, television, and FM radio. You might enjoy trying the STADIUM or ARENA mode the next time you watch a concert or sporting event! The WALL parameter lets you adjust the "brightness" of the sonic environment according to your preference. The ROOM SIZE parameter lets you adjust the size of the sonic environment according to your preference. The EFFECT level lets you adjust the "presence" of the sonic environment according to your preference.

\* The DSP mode will produce a stereo-like surround effect from monoaural sources, but there will be some reduction in the presence of the arena, jazz club, or stadium (etc.).

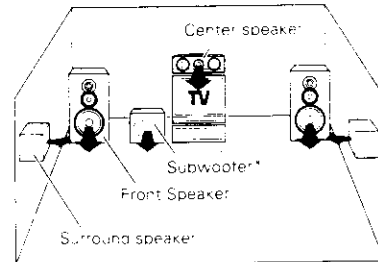

\* Optional in this mode.

## Recommended speaker installation



It is recommended that the surround speakers are installed straight to the left and right of the listening position or slightly behind, at a height of about 1 meter higher than the listener's ears.

## What is DSP?



The DSP stands for Digital Signal Processor. In the DSP presence mode, the reverberation components (elements of sound echoed in various spaces) which determine the feeling of presence are created by digital processing by the DSP without spoiling the sound quality of the original program source.

The feeling of presence in the surround effects can be improved by performing the following adjustment procedure according to the speaker system and listening room environment in use.

Once they are adjusted, re-adjustment is not necessary even after the surround mode is switched to other modes.

Adjustment sequence

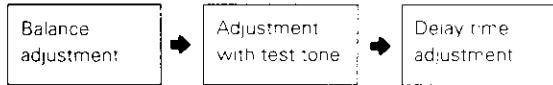

# Setup for surround play

## 1 Select the Dolby mode.

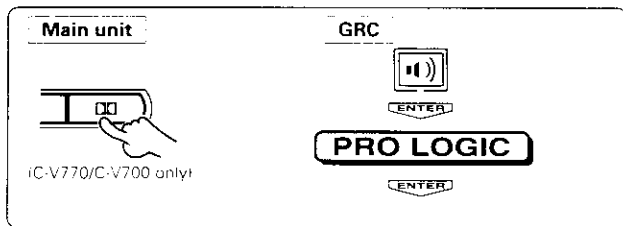

- Select the Dolby mode according to the played source and component in use.
- The AC-3 mode can be used when the Dolby Digital signal is available.
- Switching is not possible when the 6ch INPUT is used.

Main unit	
Display	Dolby mode
PRO LOGIC	Dolby Pro Logic
3 STEREO	Dolby 3 Stereo
AC-3	Dolby Digital (AC 3)

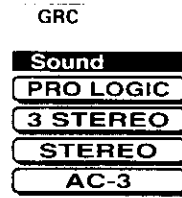

Select an icon.  
 (The displayed icons may be variable depending on the mode.)

## 2 Adjust the balance. "L-----R"

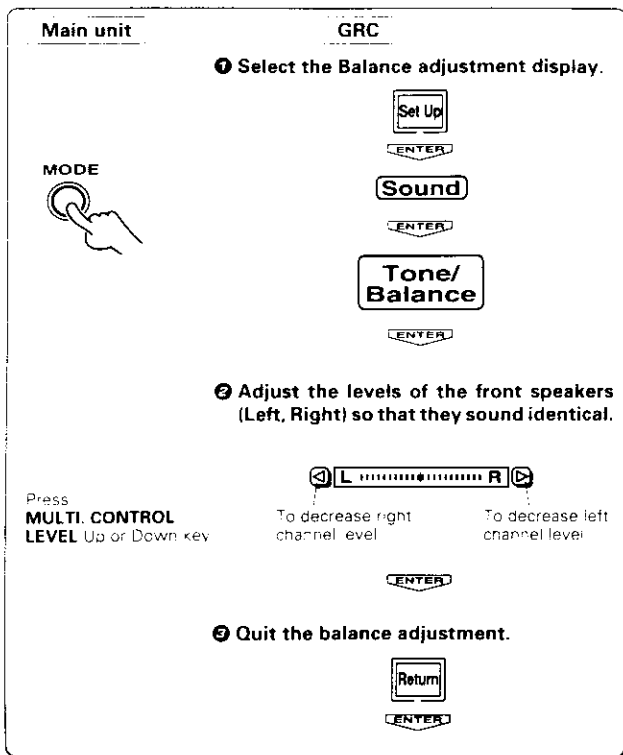

Each press switches the adjusted items as shown below

- | Main unit |                         |
|-----------|-------------------------|
| 1 BASS    | Tone, Bass              |
| 2 TREBLE  | Tone, Treble            |
| 3 L-----R | Balance                 |
| 4 C ch    | Center speaker          |
| 5 SR ch   | Surround speaker, Right |
| 6 SL ch   | Surround speaker, Left  |
| 7 SW ch   | Subwoofer               |
| 8 DELAY   | Delay time              |
| 9 INPUT   | Input level             |

- Adjustment items 5, 6 and 9 are not required in the 2 STEREO mode.
- The adjusted items which can be selected with 6ch INPUT are 3, 4, 5, 6 and 7, in this sequence.
- Those which can be selected when SOURCE DIRECT is ON are 7 and 9.

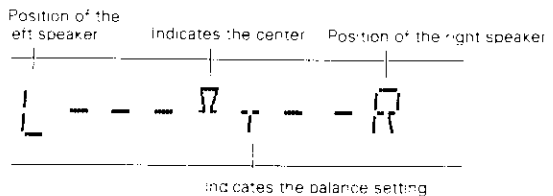

If no key on the main unit has been pressed for about 5 seconds, the display on the main unit disappears and it returns to the status before the setup mode was entered.  
 The display on the GRC disappears if no key on the GRC has been pressed for about 10 seconds.



## How to calculate the proper delay time

Assuming that the distance from the front speakers is A meters and that from the surround speakers is B meters:

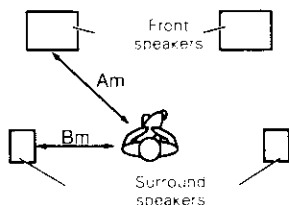

### 1 Use the delay time calculation chart on the right.

Example  
When A = 3 m, B = 3 m,  
the delay time is 20 ms.

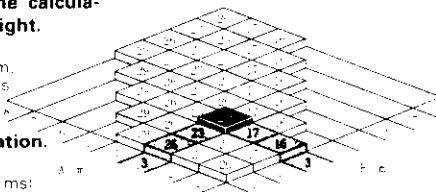

### 2 Use the following formula for calculation.

Delay time =  
 $20 + 3 \times (A - B)$  (Unit: ms)

## What is delay time?



The sound entering the ears include the direct sound coming from the sound source and the indirect sounds reflected from the walls, floor, ceiling, etc. The indirect sounds are delayed because they travel longer distance required for reflection before they reach the ears. The delay time is the difference in time between the direct sound and indirect sounds.

## 3 Adjust the level from each speaker. "Test Tone"

**Main unit**

(Remote control only)

**GRC**

1 Output the "Test Tone".

**Test Tone**

ENTER

**Test Tone**

ENTER

2 Adjust the levels of the other speakers than the front speakers (left, right).  
 (1) While test tone is output from a speaker.  
 (2) Adjust the volume level of the speaker

To decrease level:      To increase level:

ENTER

3 Quit the speaker level adjustment.

**Test Tone**

ENTER

Return

ENTER

- The test tone which sounds like noise move across speakers in the following sequence every 1.5 second

(In Pro Logic or AC-3 mode)

- ▶ **TEST Lch** (Front speaker, Left)
- TEST Cch** (Center speaker)
- TEST Rch** (Front speaker, Right)
- TEST SRch** (Surround speaker, Right)
- TEST SLch** (Surround speaker, Left)
- **TEST SWch** (Subwoofer)

(In 3 STEREO mode)

- ▶ **TEST Lch** (Front speaker, Left)
- TEST Cch** (Center speaker)
- TEST Rch** (Front speaker, Right)
- **TEST SWch** (Subwoofer)

- The test tones is not output from the speaker which has been set to off Speaker setup

TEST SRch

▷ display when test tone is output from a surround speaker

- Be sure to adjust from the listening position.
- Each press of the key increases or decrease the level by 1 dB.
- The levels of the front speaker (Left, Right) cannot be varied in step 2.

## 4 Adjust the delay time. "DELAY"

**Main unit**

MODE

Press **MULTI CONTROL LEVEL** Up or Down key

**GRC**

1 Select the Delay Time adjustment display.

**Delay Time**

ENTER

2 Adjust the Delay Time.

To decrease      To increase

ENTER

3 Quit the delay time adjustment.

Return

ENTER



### Main unit

Each press switches the adjustment items as shown below

- ▶ 1 **BASS** :Tone, Bass
- 2 **TREBLE** :Tone, Treble
- 3 **L . . . . . R** :Balance
- 4 **C ch** :Center speaker
- 5 **SR ch** :Surround speaker, Right
- 6 **SL ch** :Surround speaker, Left
- 7 **SW ch** :Subwoofer
- 8 **DELAY** :Delay time
- 9 **INPUT** :Input level

- Adjustment items 5, 6 and 8 are not required in the 3 STEREO mode.
- Find the optimum delay time for the listening room by referring to "How to calculate the delay time".
- The delay time in the PRO LOGIC mode can be adjusted between 15 and 30 ms
- The delay time in the AC-3 mode is automatically decreased by 15 ms from that set in the PRO LOGIC mode
- Select the closest value to the value obtained by "How to calculate the delay time".

DELAY 20<sup>ms</sup>

Dolby Digital (AC-3) can be used when playing DVD or LD software bearing the  mark and Dolby Digital (AC-3) format digital broadcasts (etc.). Dolby Pro Logic and Dolby 3 Stereo can be used when playing video, DVD, or LD software bearing the  mark. DSP modes can be used with any source except Dolby Digital.

Be sure to complete "Set up for surround play" before using any of these surround modes. - 34

Sound may not be reproduced when the input signal and Dolby mode are selected improperly.  
How to select the digital input, analog input and Dolby mode. - 37

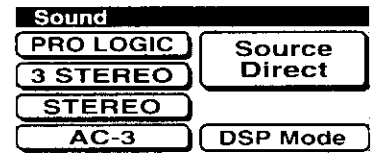

**Main operation menu**  
\*The displayed options are variable depending on the model.

# Surround play

## 1 Select the desired mode.

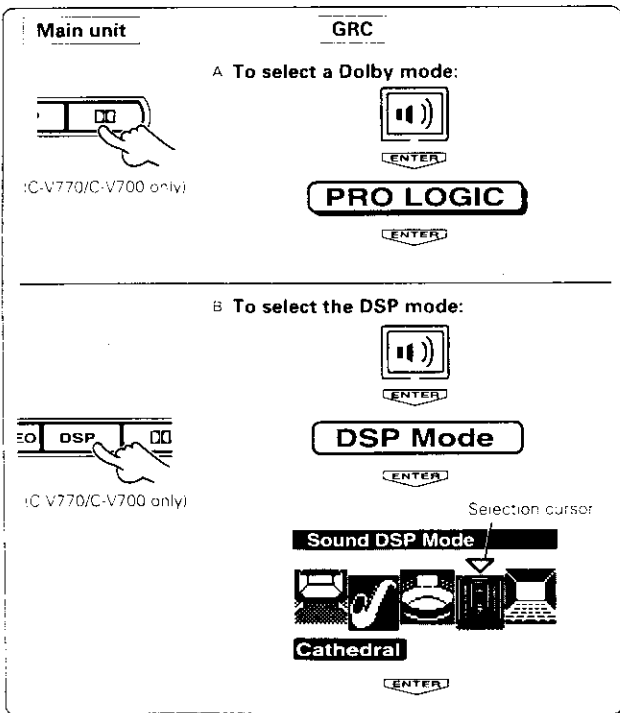

• Switching is not possible when the 6ch INPUT is used

**When a Dolby mode is selected:**

• Select the Dolby mode according to the software to be played

Main unit	Dolby mode
PRO LOGIC	Dolby Pro Logic
3 STEREO	Dolby 3 Stereo
AC-3	Dolby Digital (AC-3)

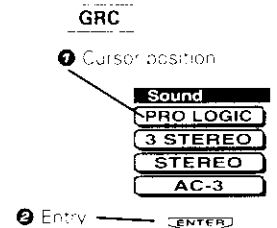

**When the DSP mode is selected:**

**Main unit**  
• This can be selected when the mode is other than Dolby Digital.  
Each press of the **DSP** key switches the sound fields as shown below

- 1 **ARENA** A lively feeling as felt in the frontmost seat in a concert arena.
- 2 **JAZZ CLUB** Sound field of a jazz live house where cymbals sound sharply.
- 3 **STADIUM** A free feeling with little reverberation reflected from the ceiling.
- 4 **CATHEDRAL** A sound field like in a church
- 5 **THEATER** A lively sound field like in a theater.

• Sound parameter adjustments in DSP mode - 44

## 2 Play video software.

## 3 Adjust the sound level.

### To end surround play

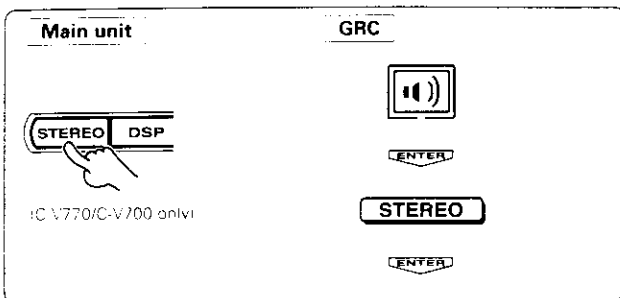

**When the source is other than Dolby Digital (AC-3)**

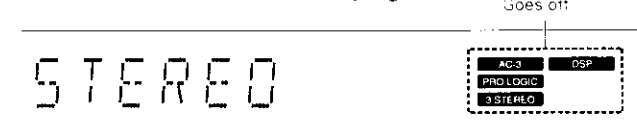

Lights for 5 sec.  
**During playback of Dolby Digital (AC-3) compatible software**

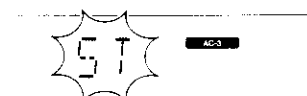

# Surround play of LD or DVD

## INPUT selector operation

### Main unit

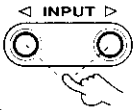

Each press switches the indication

- 1 VCR
- 2 AUX
- 3 TAPE 1 / MD
- 4 TUNER (frequency display)
- 5 CD
- 6 DVD-D
- 7 DVD-A / 6ch INPUT
- 8 LD -D
- 9 LD -A
- 10 CABLE / SAT

DVD-D : DVD Digital  
DVD-A : DVD Analogue

### GRC (Operation 1)



Each press switches the indication

- 1 VCR
- 2 AUX
- 3 TAPE 1 / MD
- 4 TUNER (frequency display)
- 5 CD
- 6 DVD-D
- 7 DVD-A / 6ch INPUT
- 8 LD -D
- 9 LD -A
- 10 CABLE / SAT

LD -D : LD Digital  
LD -A : LD Analogue

### GRC (Operation 2)



1 Select the input source icon.

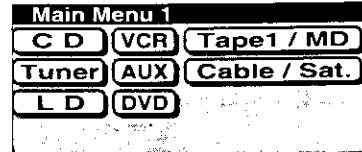

2 Press the ENTER key.



• With (Operation 2), the Digital and Analog can be switched every time the **ENTER** key is pressed after selecting "DVD" or "LD".

## Dolby mode selection

### Surround play of digital input: C-V500

INPUT selector	DVD-D		LD -D	
AC-3 AUDIO INPUT (Rear panel)	DIGITAL INPUT		DIGITAL INPUT	
Input signal	Dolby Digital (AC-3)	PCM	Dolby Digital (AC-3)	PCM
Dolby mode (display) *1	AC-3 (Dolby Digital)	1 PRO LOGIC 2 3 STEREO (DSP)	AC-3 (Dolby Digital)	1 PRO LOGIC 2 3 STEREO (DSP)

### Surround play of digital input: C-V770/C-V700/C-V550

INPUT selector	DVD-D		LD -D	
AC-3 AUDIO INPUT (Rear panel)	DIGITAL INPUT		DIGITAL RF INPUT	
Input signal	Dolby Digital (AC-3)	PCM	Dolby Digital (AC-3)	PCM
Dolby mode (display) *1	AC-3 (Dolby Digital)	1 PRO LOGIC 2 3 STEREO (DSP)	AC-3 (Dolby Digital)	_____

### Surround play of analog input

INPUT selector	DVD-A	LD -A
CONNECTION (Rear panel)	DVD (FRONT L/R)	LD (L/R)
Input signal	Analogue	
Dolby mode (display) *1	1 PRO LOGIC 2 3 STEREO (DSP)	

The setup for surround play can also be performed by listening to actual music instead of the test tone. Use the following procedure to adjust surround play while listening to music.

### Preparations

- Select the Dolby mode according to the played source and component in use - 32
- Play video software marked **DOLBY DIGITAL** or **DOLBY SURROUND**.

Setup Sound	
Test Tone	DSP
Delay Time	Tone/Balance
Speaker Level	-6dB
Input Level	

**Main operation menu**  
 (The displayed icons are variable depending on the mode.)

## Setup for surround play (while listening to music)

### 1 Select the Dolby mode.

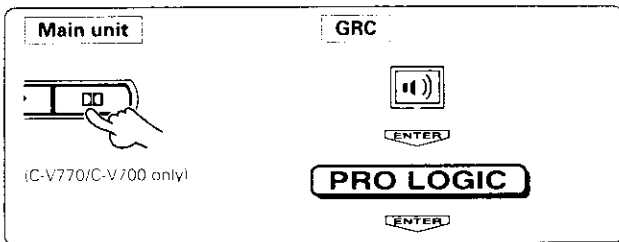

- Switching is not possible when the 6ch INPUT is used.

#### Main unit

Display	Dolby mode
PRO LOGIC	Dolby Pro Logic
3 STEREO	Dolby 3 Stereo
AC-3	Dolby Digital (AC-3)

#### GRC



Select an icon.

(The displayed icons may be variable depending on the mode.)

### 2 Adjust the adjustment item.

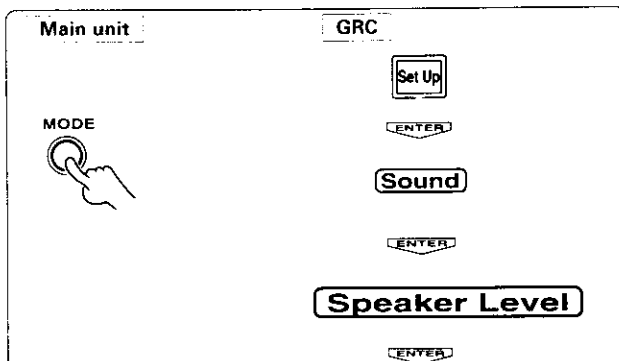

If no key on the main unit has been pressed for about 5 seconds, the display on the main unit disappears and it returns to the status before the setup mode was entered.

The display on the GRC disappears if no key on the GRC has been pressed for about 10 seconds.

#### Main unit

Each press switches the adjustment items as shown below

1 BASS	Tone, Bass
2 TREBLE	Tone, Treble
3 L-----R	Balance
4 C ch	Center speaker
5 SR ch	Surround speaker, Right
6 SL ch	Surround speaker, Left
7 SW ch	Subwoofer
8 DELAY	Delay time
9 INPUT	Input level

- Adjustment items 4, 5 and 6 are not required in the 3 STEREO mode.

#### GRC

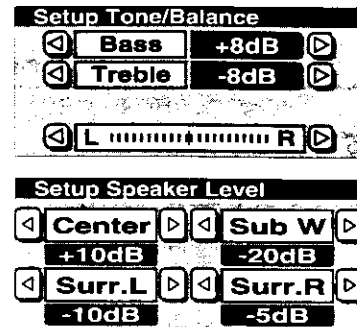

- With the GRC, the adjustment items shown in a single menu can be adjusted at once. (The adjustment steps 1, 2 and 3 or steps 4, 5, 6 and 7 are provided in a single menu so they can be adjusted successively without changing the menu screen.)

### 3 Adjust the Bass tone level. "BASS"

Main unit GRC

1 Confirm the display.  
(Select icon as required.)



ENTER

2 Adjust the level as required.



To decrease      To increase

ENTER

3 Go to adjustment step "4".

MODE Select the step "4" icon.



### 4 Adjust the Treble tone level. "TREBLE"

Main unit GRC

1 Confirm the display.  
(Select icon as required.)

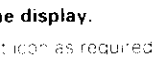

ENTER

2 Adjust the level as required.



To decrease      To increase

ENTER

3 Go to adjustment step "5".

MODE Select the step "5" icon.

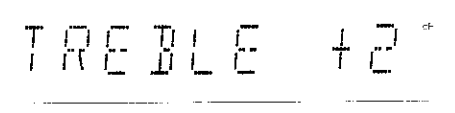
### 5 Adjust the balance. "L-----R"

Main unit GRC

1 Confirm the display.  
(Select icon as required.)

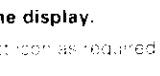

ENTER

2 Adjust the levels of the front speakers (Left, Right) so that they sound identical.



To decrease right channel level      To decrease left channel level

ENTER

3 Go to adjustment step "6".



ENTER

MODE Select the step "6" icon.

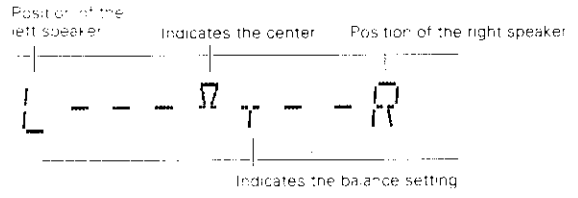
## 6 Adjust the center speaker level. "Cch"

Main unit GRC

1 Confirm the display.  
(Select icon as required.)

**Speaker Level**

ENTER

2 Adjust the level as required.

Press MULTI. CONTROL LEVEL Up or Down key

To decrease      To increase

ENTER

3 Go to adjustment step "2".

Select the step "2" icon.

MODE



## 7 Adjust the right surround speaker level. "SRch"

Main unit GRC

1 Confirm the display.  
(Select icon as required.)

2 Adjust the level as required.

Press MULTI. CONTROL LEVEL Up or Down key.

To decrease      To increase

ENTER

3 Go to adjustment step "0".

Select the step "0" icon.

MODE



## 8 Adjust the left surround speaker level. "SLch"

Main unit GRC

1 Confirm the display.  
(Select icon as required.)

2 Adjust the level as required.

Press MULTI. CONTROL LEVEL Up or Down key

To decrease      To increase

ENTER

3 Go to adjustment step "0".

Select the step "0" icon.

MODE

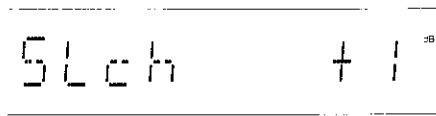

## 9 Adjust the subwoofer level. "SWch"

**Main unit** **GRC**

- Confirm the Subwoofer adjustment display.  
(Select icon as required.)
- Adjust the level as required.

Press **MULTI CONTROL LEVEL** (up or Down key)

To decrease To increase

**Sub W**  
**-20dB**

**ENTER**

- Go to adjustment step "10".

**MODE**

**Return**

**ENTER**

## To skip an adjustment item

### Main unit

- When an adjustment item is not required to be adjusted, press the **MODE** key to go to the next adjustment step

### GRC

- Select only the icons of the adjustment items which require adjustment

SWch + 10"

- The level can be adjusted between -20 and +10 dB in steps of 1 dB.

## 10 Adjust the delay time. "DELAY"

**Main unit** **GRC**

- Confirm the display.  
(Select icon as required.)
- Adjust the delay time.

Press **MULTI CONTROL LEVEL** (up or Down key)

To decrease To increase

**Delay Time**  
**20msec**

**ENTER**

- Go to adjustment step "11".

**MODE**

**Return**

**ENTER**

- Find the optimum delay time for the listening room by referring to "How to calculate the delay time"
- The delay time in the PRO LOGIC mode can be adjusted between 15 and 30 ms
- The delay time in the AC-3 mode is automatically decreased by 15 ms from that set in the PRO LOGIC mode.
- Select the closest value to the value obtained by "How to calculate the delay time"

DELAY 20 ~

Delay time

## 11 Adjust the input level. "INPUT"

**Main unit** **GRC**

- Confirm the display.  
(Select icon as required.)
- Set the input level.

Press **MULTI CONTROL LEVEL** (up or Down key)

**Input Level** **-6dB**

**ENTER** Each press changes the level.

**MULTI CONTROL LEVEL** (up or Down key)

If the **OVER LEVEL** indicator lights with analog input, set the input level to -6 dB to avoid sound distortion

- The input level can be set to -6 dB or 0 dB
- This adjustment is not available with 6ch INPUT.

INPUT -6 dB

## To quit the setup operation:

### GRC

**Main Menu**

**ENTER**

- If no key on the main unit has been pressed for about 5 seconds, the display on the main unit disappears and it returns to the status before the setup mode was entered
- The display on the GRC disappears if no key on the GRC has been pressed for about 5 seconds

# Setup of other speakers than those used by system SERIES 21

The following setup operation is not required if the speakers provided with KENWOOD system SERIES 21 are used. The following procedure is necessary when other speakers than those provided with system SERIES 21 or used or when you do not want to output sound from speakers. After "Setup of the speaker sizes and speaker ON/OFF", execute the "Setup for surround play" (→ 34) again.

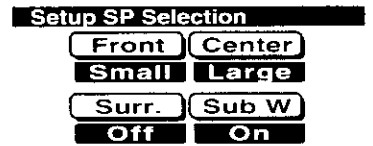

Main operation menu  
The first and second icons are selected.

## Setup of the speaker sizes and speaker ON/OFF

### 1 Select the speaker setup mode.

**Main unit** **GRC**

**MODE**

Press and hold for more than 2 sec.

**Set Up**  
ENTER

**Speaker**  
ENTER

**Main unit**

**Procedure** Press and hold the **MODE** key for more than 2 seconds. Press the **MULTI. CONTROL LEVEL UP** key repeatedly to switch the setup contents as shown below.

- **2** Subwoofer ON/OFF setup
- **3** Front speaker size setup
- **4** Center speaker size setup
- **5** Surround speaker size setup

Press the **MODE** key to abort setup in the middle.

### 2 Set up the subwoofer. "SW"

**Main unit** **GRC**

**1** Select ON or OFF.  
(Select icons.)

Press **MULTI. CONTROL LEVEL** Down key.

**Sub W**  
**On**  
ENTER

Each press changes the setup.

**2** Go to adjustment step "3".  
Select the step "3" con.

Press **MULTI. CONTROL LEVEL** Up key.

**Main unit**

Each press of the **MULTI. CONTROL LEVEL DOWN** key switches the Subwoofer ON and OFF.

**GRC**

Each press of the **ENTER** key switches the Subwoofer as shown below.

- **SW OFF** Subwoofer Off
- ← **SW ON** Subwoofer On

● When "SW" is set to OFF, "F" is automatically set to "LARGE"

### 3 Set the front speaker size. "F"

**Main unit** **GRC**

**1** Select LARGE or SMALL.  
(Select icons.)

Press **MULTI. CONTROL LEVEL** Down key.

**Front**  
**Small**  
ENTER

Each press changes the setup.

**2** Go to adjustment step "4".  
Select the step "4" icon.

Press **MULTI. CONTROL LEVEL** Up key.

**Main unit**

Each press of the **MULTI. CONTROL LEVEL DOWN** key switches the Front speaker size.

**GRC**

Each press of the **ENTER** key switches the Front speakers as shown below.

- **F LARGE** Setup for large-sized front speakers
- ← **F SMALL** Setup for small-sized front speakers

● When "SW" is set to ON and "F" is set to SMALL, "C" and "S" are set automatically SMALL even if they have been set to LARGE.



## 4 Set the center speaker size. "C"

**Main unit** **GRC**

➊ Select **LARGE**, **SMALL** or **OFF**.  
(Select icons)

Press **MULTI CONTROL LEVEL** Down key

**Center**  
**Small**

**ENTER**

Each press changes the setup.

➋ Go to adjustment step "B".  
Select the step "B" icon

Press **MULTI CONTROL LEVEL** Up key

## 5 Set the surround speaker size. "S"

**Main unit** **GRC**

➊ Select **LARGE**, **SMALL** or **OFF**.  
(Select icons)

Press **MULTI CONTROL LEVEL** Down key

**Surr.**  
**Small**

**ENTER**

Each press changes the setup.

➋ Go to adjustment step "B".  
Select the step "B" icon

Press **MULTI CONTROL LEVEL** Up key

### To quit the setup operation:

**Main unit** **GRC**

**MODE**



**Confirm**

**ENTER**

### Main unit

Each press of the **MULTI CONTROL LEVEL DOWN** key switches the Center speaker size.

### GRC

Each press of the **ENTER** key switches the Center speaker size as shown below.

- ➊ **C LARGE** Setup for large-sized center speaker
- ➋ **C OFF** Setup for not using the center speaker
- ➌ **C SMALL** Setup for small-sized center speaker

- When "SW" is set to ON and "F" is set to SMALL, "C" and "S" can be set only to SMALL or OFF.

### Main unit

Each press of the **MULTI CONTROL LEVEL DOWN** key switches the Surround speaker size.

### GRC

Each press of the **ENTER** key switches the Surround speakers size as shown below.

- ➊ **S LARGE** Setup for large sized surround speakers
- ➋ **S OFF** Setup for not using the surround speaker
- ➌ **S SMALL** Setup for small-sized surround speakers

- When "SW" is set to ON and "F" is set to SMALL, "C" and "S" can be set only to SMALL or OFF.

- The display on the GRC disappears if no key on the GRC has been pressed for about 10 seconds.

### Notes for surround play

When the surround speakers are set to OFF in the middle of Dolby Pro Logic mode, this is automatically switched to the Dolby 3 Stereo mode.

When the center speaker is set to OFF in the middle of 3 STEREO mode, this will automatically be switched to the normal STEREO mode.

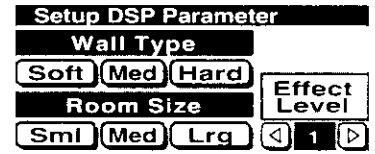

**Main operation menu**

The displayed icons are variable depending on the mode.

# Setup of the surround effect parameters (DSP)

## 1 Select the DSP surround mode.

**Main unit**

① Select DSP.

MODE

DSP

ENTER

DSP Mode

ENTER

(C/V700/C/V770 only)

**GRC**

① Select DSP.

ENTER

DSP Mode

ENTER

- This can be selected when the input signal is other than Dolby Digital (AC 3).

**Main unit**

Each press switches the indication

- 1 ARENA
- 2 JAZZ CLUB
- 3 STADIUM
- 4 CATHEDRAL
- 5 THEATER

**GRC**

① Selection cursor

Sound DSP Mode

Arena

② Entry

ENTER

- The effects of adjustments are applied equally to sound fields 1 to 5.
- Switching is not possible when the 6ch INPUT is used.

## 2 Select the adjustment parameter.

**Main unit**

MODE

① Display the setup screen.

Set Up

ENTER

Sound

ENTER

DSP

ENTER

To quit the setup mode in the middle:  
If no key has been pressed for about 5 seconds, the setup display disappears and the display returns to the status before the setup mode was entered.  
(Main unit display)

**GRC**

① Display the setup screen.

Set Up

ENTER

Sound

ENTER

DSP

ENTER

**Main unit**

Each press switches the adjustment parameter

- 1 EFFECT
- 2 WALL
- 3 ROOM
- 4 BASS
- 5 TREBLE
- 6 L-----R
- 7 Cch
- 8 SRch
- 9 SLch
- 10 SWch
- 11 INPUT

**GRC**

Selection adjustment parameter by moving the cursor

Setup DSP Parameter

Wall Type

Soft Med Hard

Room Size

Sml Med Lrg

Effect Level

1

- Setup/adjustment operations 2 to 11 are to be performed only when required.

## 3 Adjust the effect level. "EFFECT"

**Main unit**

Press MULTI CONTROL LEVEL Up or Down key

MODE

① Confirm the "EFFECT" Level adjustment display.

Effect Level

② Adjust the level as required.

③ Enter the setup.

Go to adjustment step "2".

**GRC**

Select icon as required.

Select the step "2" icon.

To decrease To increase



- The EFFECT level can be adjusted between 1 and 5.

## 4 Set the WALL type. "WALL"

**Main unit** GRC

1 Confirm "WALL" adjustment display.

2 Select the type.

Press **MULTI CONTROL LEVEL** Up or Down key.

**Wall Type**  
**Soft Med Hard**

3 Enter the setup.

MODE  ENTER

Select the step "3" icon.

Go to adjustment step "2".

### Main unit

- Each press of the key switches the type setup as shown below.

S ↔ M ↔ H  
(SOFT) (MEDIUM) (HARD)

## 5 Set the ROOM size. "ROOM"

**Main unit** GRC

1 Confirm "ROOM" adjustment display.

2 Select the size.

Press **MULTI CONTROL LEVEL** Up or Down key.

**Room Size**  
**Sml Med Lrg**

3 Enter the setup.

MODE  ENTER

Go to adjustment step "2".

### Main unit

- Each press of the key switches the size setup as shown below.

S ↔ M ↔ L  
(SMALL) (MEDIUM) (LARGE)

#### To quit the setup mode in the middle:

If no key has been pressed for about 5 seconds, the setup display disappears and the display returns to the status before the setup mode was entered.

- Setup/adjustment operations 2 to 4 are to be performed only when required.  
The operations are identical to those in "Setup for surround play (while listening to music)".

### To return the GRC display to the Main Menu:

GRC

**Main Menu**

ENTER

- If no key on the main unit has been pressed for about 5 seconds, the display on the main unit disappears and it returns to the status before the setup mode was entered.
- The display on the GRC disappears if no key on the GRC has been

# Clock adjustment

CV770/CV700/CV550/CV500 (E)/M

This unit incorporates a clock function. Be sure to adjust the correct time before using the timer function.

The time display blinks after a power failure or when the power cord has been unplugged from the AC outlet and plugged in again. In such a case, adjust the clock again.

## 1 Activate the clock adjustment mode.

### Main unit

1 Enter the adjustment mode.

Press **CLOCK** key.

Example: Adjustment to 8:15



• The time display starts to blink.

## 2 Enter the hour.

### Main unit

1 Set the "hour".

Press **TUNING** key.  
Up key  
To increase the figure

Down key  
To decrease the figure

2 Enter it.

Press **CLOCK** key.

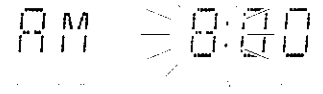

- The time is represented in 12-hour AM/PM method.
- Press the **CLOCK** key. The hour is entered and the minute display starts to blink.

## 3 Enter the minute.

### Main unit

1 Set the "minute".

Press **TUNING** key.  
Up key  
To increase the figure

Down key  
To decrease the figure

2 Enter it.

Press **CLOCK** key.

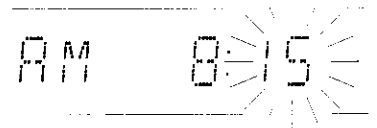

- If you make a mistake, restart from the beginning.
- To adjust correct time, press the **CLOCK** key at the same moment as a time announcement.

# Displaying the Time

The displayed information can be switched every time the Display icon is selected.

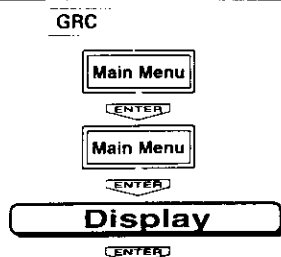

Each press switches the indication.

- 1 Input selection display
- 2 DOLBY/DSP/STEREO display
- 3 Clock display (about 5 seconds)

89.00 → PRO LOGIC → AM 8:17

# Timer operation

CV770/CV700/CV550/CV500 (En/MT)

Two 24-hour timer systems (TIMER 1, TIMER 2) (which can be used every day) and a sleep timer system (which works only once) are available.

In each of TIMER 1 and TIMER 2, the timer data including the operating period and played contents can be set and selected to be activated or not as required.

Timer reservation is possible for the two types **TIMER 1** and **TIMER 2** at the same time.

- Please make reservations with an interval of at least one minute, so that the operation times of **TIMER 1** and **TIMER 2** do not overlap.

## Timer playback, timer recording (TIMER 1, TIMER 2)

With each of the two timer programs, a selected source can be played for radio broadcast, can be recorded in the previously set time period.

### Sleep timer

The unit is put to **STANDBY** mode automatically after the specified period has elapsed. — 50

## Timer programming

### 1 Make preparations for the play (recording).

- To listen to radio

The station should be preset before timer programming. — 29 – 30

- To listen to CD

Insert a disc.  
(Program playback is not possible.)

- To listen to tape

Insert a tape.

- To listen to LD

Insert a disc.  
(Program playback is not possible.)

- For broadcast recordings

Make preparations for recording. — 27

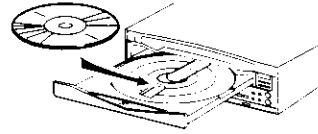
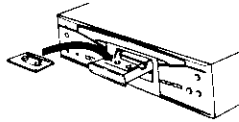
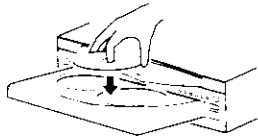

If tapes are inserted in both decks A and B, playback starts with the tape in deck B.

### 2 Adjust the listening volume.

Main unit

VOLUME CONTROL

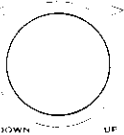

- The **VOLUME CONTROL** should be set to the desired volume while the unit is **ON**.

### 3 Set the **POWER** or **I / ⏻** (ON/STANDBY) switch to **STANDBY**.

Main unit

I / ⏻



ON/STANDBY

### 4 Select a **TIMER No.**

Main unit

- 1 Select the timer number.

Press **TIMER MODE** key.

- 2 Press immediately after selection.

Press **TIMER SET** key.

Each press of the key switches the **TIMER** numbers as follows.

- 1 **TIMER 1**
- 2 **TIMER 2**
- 3 **TIMER 1,2**
- 4 **OFF**

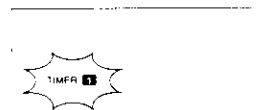

- The selected **TIMER No.** lights.
- If a previously programmed **TIMER No.** is selected, the contents will be replaced by the new contents programmed.
- The timer programming operation is not possible when **TIMER 1,2**.

## 5 Enter the ON time (Hour).

### Main unit

#### 1 Set the "hour".

Press **TUNING** key  
Up key  
To increase the figure

Down key  
To decrease the figure

#### 2 Enter it.

Press **TIMER SET** key

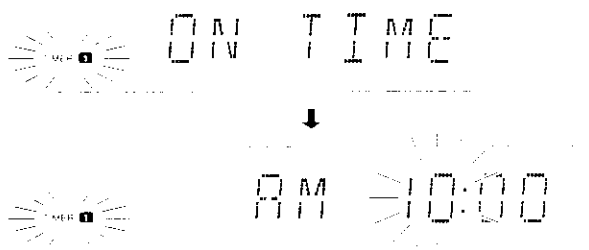

- If you make a mistake, restart from step 1.

## 6 Enter the On time (Minute).

### Main unit

#### 1 Set the "minute".

Press **TUNING** key  
Up key  
To increase the figure

Down key  
To decrease the figure

#### 2 Enter it.

Press **TIMER SET** key



- After entering the figure of "hour" with the procedure in step 5, enter the figure of "minute" using the same procedure.

- If you make a mistake, restart from step 4.

## 7 Enter the OFF time (Hour).

### Main unit

#### 1 Set the "hour".

Press **TUNING** key  
Up key  
To increase the figure

Down key  
To decrease the figure

#### 2 Enter it.

Press **TIMER SET** key

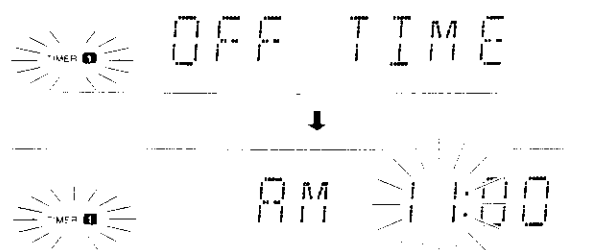

- If you make a mistake, restart from step 4.

## 8 Enter the OFF time (Minute).

### Main unit

#### 1 Set the "minute".

Press **TUNING** key  
Up key  
To increase the figure

Down key  
To decrease the figure

#### 2 Enter it.

Press **TIMER SET** key



- After entering the figure of "hour" with the procedure in step 7, enter the figure of "minute" using the same procedure.

- If you make a mistake, restart from step 4.

## 9 Make the desired reservation.

### For timer playback

**Main unit**

**1 Select the mode.**

Press **TUNING** Up or Down key

1 Select "PLAY"  
(Each press alternates them.)

→ **PLAY** At the ON time, playback starts  
→ **REC**

Press **TIMER SET** key

1 Enter it.



**2 Select the input source.**

1 Select the source to be played.  
(Each press switches the following)

Press **TUNING** Up or Down key

→ **TUNER**  
→ **CD**  
→ **LD -D**  
→ **LD -A**  
→ **TAPE1 / MD**  
→ **DVD-D**  
→ **DVD-A / 6ch INPUT**

Press **TIMER SET** key

1 Enter it.



**3 Select the broadcast station (only when TUNER is selected above).**

Press **TUNING** Up or Down key

1 Select the preset station No.



Press **TIMER SET** key

1 Enter it.

- The station to be received with timer must be preset beforehand.

→ 29 → 30

### Timer recording of broadcasts

**Main unit**

**1 Select the mode.**

Press **TUNING** Up or Down key

1 Select "REC".  
(Each press alternates them.)

→ **PLAY**  
→ **REC**

Press **TIMER SET** key

1 Enter it.

Press **TIMER SET** key

**2 Select the broadcast station.**

Press **TUNING** Up or Down key

1 Select the preset station No.



Press **TIMER SET** key

2 Enter it.

## Activating the timer

### 1 Select the **TIMER** No. to be used.

**Main unit**

Press **TIMER MODE** key

Each press of the key switches the **TIMER** numbers as follows

- 1 **TIMER 1** ..... Execution of timer 1 only.
- 2 **TIMER 2** ..... Execution of timer 2 only.
- 3 **TIMER 1, 2** ... Execution of timers 1 and 2
- 4 **TIMER OFF**

- The selected **TIMER** No. lights
- The timer will not function unless a **TIMER** No. is selected.

## Timer operation

CV77D/CV79D/CV55D/CV50D (Er/M)

The reservation contents cannot be cleared. The contents are cleared only when they are changed.

Each press of the key switches the **TIMER** numbers as follows.

- 1 **TIMER 1** (Contents of the timer 1 are displayed.)
- 2 **TIMER 2** (Contents of the timer 2 are displayed.)
- 3 **TIMER 1, 2** (Contents of the timer 1 and timer 2 are displayed.)
- 4 **TIMER OFF**

- The reserved contents will be displayed for 2 seconds per item. After this, the previous display content appears again.

### To change the reserved contents

Restart the procedure of "Timer programming" from the beginning.

## Check the reservation content.

Main unit

Select the **TIMER** number to be checked.

Press **TIMER MODE** key.

## When timer operation is not required

Main unit

Press so that all **TIMER No.** indicators are **OFF**.

Press **TIMER MODE** key.

## To set the same timer program again

Main unit

Press so that the desired **TIMER No.** indicators light.

Press **TIMER MODE** key.

Each press of the key switches the **TIMER** numbers as follows.

- 1 **TIMER 1** (Only the timer 1 is carried out.)
- 2 **TIMER 2** (Only the timer 2 is carried out.)
- 3 **TIMER 1, 2** (Both timers 1 and 2 are carried out.)
- 4 **TIMER OFF** (No timer operation is carried out.)

- The reservation contents are held in memory.

Each press of the key switches the **TIMER** numbers as follows.

- 1 **TIMER 1** (Only the timer 1 is carried out.)
- 2 **TIMER 2** (Only the timer 2 is carried out.)
- 3 **TIMER 1, 2** (Both timers 1 and 2 are carried out.)
- 4 **TIMER OFF** (No timer operation is carried out.)

- Also prepare the disc or tape and adjust the listening volume.

## Sleep timer

Setting the number of minutes until the unit is put to standby mode.

Main unit

GRC

- Switch the unit from **STANDBY** mode to **ON** mode.



- Set the time.



- This unit is turned **STANDBY** automatically after the set time has elapsed.
- The remaining sleep time can be displayed by selecting the Sleep icon while the **SLEEP** indicator is lit.

- Each press decreases the time by 10 minutes. The maximum time that can be set is 90 minutes.

90→80→70...30→20→10→Cancel→90→80...

Lights up

SLEEP

SLEEP 90

Duration for sleep timer.

### To cancel

Turn **STANDBY** or select "Sleep" icon repeatedly until the sleep time is cancelled.



# Set up code chart

CV770/CV700/CV550/CV500 (EN/M)

## VCR Set up codes

Maker	Set up codes
ADVENTURA	015
AIKO	293
AIWA	015
AKAI	056,064,068,076,257
AMERICAN HIGH	050
ASHA	255
AUDIOVOX	052
BEAUMARK	256
BELL & HOWELL	119
BROKSONIC	136,199,226,310,376
CALIX	052
CANON	050,182
CAPEHART	035
CARVER	096
CCE	087,293
C-TIZEN	052,293
COLT	087
CRAIG	052,062,087,255,286
CURTIS MATHES	050,056,075
CYBERNEX	255
DAEWOO	035,060,102,293
DAYTRON	035
DYNATECH	015
ELECTROHOME	052
ELECTROPHONIC	052
EMEREX	047
EMERSON	015,017,052,058,076, 136,199,223,224,226, 227,309,310,376
FISHER	062,069,081,119
FUJII	048,050
FUNAI	015
GARRARD	015
GE	050,075,080,217
GO VIDEO	247,294
GOLDSTAR	033,052,053
GRADIENTE	015
HARLEY DAVIDSON	015
HARVANKARDON	053,090
HARWOOD	087
HEADQUARTER	061
HI-Q	062
HITACHI	056,057,080,097,120,187
JENSEN	056
JVC	023,056,082
KENWOOD	053,056,082
KLH	087
KODAK	050,052
LLOYD	015
LLOYD	023

Maker	Set up codes
LOGIK	087
LXI	052
MAGNAVOX	050,054,096,125,164
MAGNIN	225
MARANTZ	050,096
MARTA	052
MATSUSHITA	050
MEI	050
MEMOREX	015,050,052,054,061, 062,063,119,225
MGA	058,076
MGA TECHNOLOGY	255
MINOLTA	057,120
MITSUBISHI	058,076,082,090,188, 229,257
MOTOROLA	050,063
MTC	015,255
MULTITECH	015,087
NAD	073
NEC	053,055,056,065,082, 097
NIKKO	052
NOBLEX	255
OLIMPUS	050,241
OPTONUS	052,063,073,119
OPTONICA	077
PANASONIC	050,092,240,241
PENNEY	050,052,053,055,057, 069,255
PENTAX	057,080,120
PHILCO	050
PHILIPS	050,077,096,125
PILOT	052
PIONEER	073,082
PORTLAND	035
PROTEC	087
PULSAR	054
QUARTER	061
QUARTZ	061
QUASAR	050,092
RADIO SHACK	015,052
RADIX	052
RANDEX	052
RCA	057,075,080,092,120, 164,217
REALISTIC	015,050,052,061,062, 063,077,081,119,255
RICOH	049
RUNCO	054
RUNCO	060,063,055

Maker	Set up codes
SANKY	054,063
SANSUI	056,082,097,286
SANYO	061,062,119,255
SCOTT	058,060,136,199,225, 226,227
SEARS	050,052,057,061,062, 069,081,119,120
SHARP	063,077
SHINTOM	087
SHOGUN	255
SINGER	087
SONY	047,048,049,050
STS	057
SYLVANIA	015,050,058,096,125
SYMPHONIC	015
TATUNG	056
TEAC	015,056
TECHNICS	050,177
TEKNIKA	015,050,052,067
TMK	223,255
TOSHIBA	058,060,081,225,227
TOTEVISION	052,255
UNITECH	255
VECTOR	060
VECTOR RESEARCH	053,055
VIDEO CONCEPTS	055,060,076
VIDEOSONIC	255
WARDS	015,050,057,062,063, 077,087,164,227,255
XR-1000	015,050,087
YAMAHA	053
ZENITH	048,049,054

## TV Set up codes

Maker	Set up codes
A-MARK	018
ABEX	047
ADMIRAL	108
ADVENTURA	061
AIKO	107
AKAI	045,113
ALARON	231
ALLERON	194,198
AMBASSADOR	192
ANAM	019,195
ANAM NATIONAL	070
AOC	018,034,045,067,152, 200
ARCHER	018
AUDIOVOX	018,195
BELCOR	034
BELL & HOWELL	031,169
BRADFORD	195
BROCKWOOD	034
BROKSONIC	018
CANDLE	045,061,071,201
CARVER	069
CCE	232
CELEBRITY	015
CITIZEN	045,054,061,071,075, 107,201,295
CLAIRTONE	200
CONCERTO	071
CONTEC	173,195,200
CRAIG	195
CROWN	054,195
CURTIS MATHES	045,054,075,169
CXC	195
DAEWOO	034,054,106,107,466
DAYTRON	034
DUMONT	032,034
DYNATECH	064
ELECTROBAND	015,200
EMERSON	034,053,054,169,173, 192,193,194,195,196, 197,198,200,251,285, 295,297,478
ENVISION	045
FISHER	169,174
FUJITSU	194
FUNAI	194,195
FUTURETECH	195
GE	036,042,044,062,066, 070,150,189,193,297
GIBRALTER	032,034,045

Maker	Set up codes
GOLDSTAR	016,017,034,045,047, 054,071,121,193
GRUNPY	194,195
HALLMARK	193
HARVARD	195
HITACHI	047,053,071,110,112, 160,166,188,242
IMA	195
INFINITY	069
JANEIL	061
JBL	069
JCB	015
JENSEN	065
JVC	051,068,197
KAMP	231
KAWASHO	173,231,323
KAYPANI	067
KENWOOD	034,045,171
KLOSS	039,061
KMC	121
KTV	045,054,195,198,200, 232,295
LOGIK	031
LUXMAN	071
LXI	062,069,163,169,171, 193
MAGNAVOX	045,051,069,111,201
MAJESTIC	031
MARANTZ	045,069
MATSUI	232
MEGATRON	018,160,193
MEI	200
MEMOREX	031,071,121,165,169, 193
MGA	034,045,165,170,193
MIDLAND	032,047,054,062,066, 150
MINUTZ	036
MITSUBISHI	034,113,165,170,193
MOTOROLA	070,108
MTC	034,045,064,071,075, 106,200
MULTITECH	064,195,232
NAD	171,181,193
NEC	034,045,051,071,185
NIKKO	045,107,193,332
NTC	107
ONWA	195
OPTIMUS	169,181
OPTONICA	108,180

Maker	Set up codes
ORION	251
PANASONIC	066,069,070,177,265, 353
PENNEY	017,018,033,034,036, 042,045,047,054,062, 066,075,125,150,164, 171,193
PHILCO	034,045,069,111
PHILIPS	069
PILOT	034,045,054
PIONEER	053,181
PORTLAND	034,054,107
PRICECLUB	075
PRISM	066
PROSCAN	062
PROTON	018,046,067,193
PULSAR	032
PULSER	034
QUASAR	066,070,265
RADIO SHACK	034,047,054,180,195
RCA	023,034,044,053,062, 105,150,189
REALISTIC	034,045,047,054,071, 169,180,193,195
RHAPSODY	198,200,231
RUNCO	032,045
SAMPO	045,047,054,067,115, 125
SAMSUNG	034,045,047,054,071, 075,125,193
SAMSUX	054
SANYO	161,169,174
SCIMITSU	034
SCOTCH	193
SCOTT	034,193,194,195,251
SEARS	062,069,071,161,163, 164,169,171,174,186, 193,194
SHARP	054,108,180
SHOGUN	034
SIGNATURE	031
SIMPSON	201,202
SONY	015,026,095,126,288
SOUNDESIGN	193,194,195,201
SPECTRICON	018,152
SQUAREVIEW	186
SSS	034,195
STARLITE	195
SUPREMACY	061
SUPREME	015

## TV Set up codes

Maker	Set up codes
SYLVANIA	045,069,080,111
SYMPHONIC	186
TANDY	108
TATUNG	018,064,070
TECHNICS	066,265
TECHWOOD	066,071
TEKNIKA	031,034,054,069,071, 075,107,165,194,195, 201,327,337
TERA	046
TMK	071,192,193
TOSHIBA	051,075,164,169,171
TOSONIC	200
TOTEVIS OR.	054
ULTRA	406
UNIVERSAL	042
VECTOR RESEARCH	045
VICTOR	068,265
VIDECONCEPTS	113
VIDEKRON	069
VIDTECH	034,193
V-KING	061
WARDS	031,034,035,036,042, 043,044,045,069,071, 095,111,126,180,189, 193,194
YAMAHA	034,045
ZENITH	031,032
ZONDA	108

## Cable Set up codes

Maker	Set up codes
ABC	016,018,022,023,026, 028,029,032,062
ANTRONIX	222
ARCHER	054,168,222
CENTURY	168
CITIZEN	168
COLOUR VOICE	040,046
COMBAND	247,248
COMTRONICS	055,075
CONTEC	034
EASTERN	017
ELECTRICORD	093
FOCUS	415
GARRARD	168
GC ELECTRONICS	222
GE	247,248
GEMINI	030,072,085,257
GENERAL ELECTRIC	026,291
GOLDSTAR	055,159
HAMLIN	024,035,049,274,288
HITACH	026
HITEX	022
JASCO	168
JERROLD	018,026,027,029,030, 039,062,113,291
MACOM	048
MAGNAVOX	042
MEMOREX	015
MOVIE TIME	078,093,171
NORTHCOAST	329
NSC	078,085,171
OAK	022,034,263
PANASONIC	036,122
PARAGON	015
PHILIPS	040,042,043,044,045, 046,168,257,305
PIONEER	038,159,275
PSYCHE ELECTRONICS	415
PULSAR	015
RCA	036
REALISTIC	222
RECOTON	415
REGAL	035,274,288,294
REGENCY	017
REMBRANDT	026,085
RUNCO	015
SAMSUNG	055,159
SPECTRUM ELECTRONICS	021,023,032,292
SIGNAL	030,055
SIGNATURE	026

Maker	Set up codes
SL MARX	055
SPRUCER	036,322
STANDARD ELECTRONICS	111
STARCOM	018,030,062,113
STARGATE	030,055
STARQUEST	030
SYLVANIA	016
TANDY	273
TATUNG	112
TEKNIKA	161
TELECAPTION	236
TELEVIEW	055
TEXSCAN	016,111
TOCOM	027,028,074
TOSHIBA	015
TUSA	030
TV86	078
UNIKA	168,222
UNITED ARTISTS	022
UNITED CABLE	018
UNIVERSAL	054,092,093,168,206, 222,337
VIDEOWAY	265
VIDTECH	259
VIEWSTAR	042,075,078,226,273, 304
ZENITH	015,069
ZENTEK	415

**LD Set up codes**

Maker	Set up codes
AIWA	218
CARVER	079
DENON	187
FUNAI	218
KENWOOD	273
MAGNAVOX	232,256
MARANTZ	079
MITSUBISHI	074
NAD	074
PANASONIC	219
PHILIPS	079
PIONEER	074
QUASAR	219
RCA	366
REALISTIC	218
SHARP	016
SONY	208,216
YAMAHA	232

**Satellite Set up codes**

Maker	Set up codes
BIRDVIEW	060
CHANNEL MASTER	033
CHAPARRAL	068
CITOH	179
DRAKE	033,079
ECHOSTAR	163,174,233,284,295, 327
GENERAL INSTRUMENT	053,065
MACOM	033,065
MEMOREX	284
PROSAT	173
RCA	581
REALISTIC	067
STS	052
UNIDEN	067,089,091
ZENITH	079

# Specifications

CV770/CV700/CV550/CV500 (En/M)

⚠ **Caution** : Read this page carefully to ensure safe operation.

## For C-V770

### Audio section

Total harmonic distortion (1 kHz, 1V)	0.01 %
Signal to noise ratio (IHF'66)	
CD	98 dB
Input sensitivity / impedance	
CD	200 mV / 47k $\Omega$
Tone controls	
BASS	$\pm 8$ dB (at 100 Hz)
TREBLE	$\pm 8$ dB (at 10 kHz)
Output level / impedance	
TAPE REC	200 mV / 1 k $\Omega$

### Video section

VIDEO inputs / outputs (composite)	1 Vp-p/75 $\Omega$
---------------------------------------	--------------------

### Digital section

Sampling frequency	32 kHz, 44.1 kHz, 48 kHz
Digital input (coaxial)	0.5 Vp-p/75 $\Omega$
Digital RF input (coaxial)	50 mVp-p~200 mVp-p

### FM Tuner section

Tuning frequency range	87.5 MHz~108 MHz
Usable sensitivity	
MONO	1.6 $\mu$ V (at 75 $\Omega$ ) / 15.2 dBf (75 kHz dev., SINAD. 30 dB)
50dB quieting sensitivity	
STEREO	31.6 $\mu$ V (at 75 $\Omega$ ) / 41.2 dBf (75 kHz dev.)
Signal to noise ratio (1 kHz, 75 kHz dev.)	
MONO	75 dB (65.2 dBf input)
STEREO	68 dB (65.2 dBf input)
Selectivity (IHF $\pm$ 400 kHz)	50 dB
Stereo separation (1 kHz)	40 dB
Frequency response	30 Hz~15 kHz, + 0.5 dB, - 3.0 dB

### AM Tuner section

Tuning frequency range	(9 kHz) 531 kHz ~ 1,602 kHz (10 kHz) 530 kHz ~ 1,610 kHz
Usable sensitivity (30% mod., S/N 20 dB)	16 $\mu$ V / (600 $\mu$ V / m)
Signal to noise ratio (at 30% mod. 1mV input)	48 dB

### General

Power consumption	35 W
AC outlet	
UN SWITCHED	2: (Total 100 W max)
Dimensions	W:400 mm H:105 mm D:382 mm
Weight (net)	5.2 kg

## For C-V700

### Audio section

Total harmonic distortion (1 kHz, 1V)	0.01 %
Signal to noise ratio (IHF'66)	
CD	98 dB
Input sensitivity / impedance	
CD	200 mV / 47k $\Omega$
Tone controls	
BASS	$\pm 8$ dB (at 100 Hz)
TREBLE	$\pm 8$ dB (at 10 kHz)
Output level / impedance	
TAPE REC	200 mV / 1 k $\Omega$

### Video section

VIDEO inputs / outputs (composite)	1 Vp-p/75 $\Omega$
---------------------------------------	--------------------

### Digital section

Sampling frequency	32 kHz, 44.1 kHz, 48 kHz
Digital input (coaxial)	0.5 Vp-p/75 $\Omega$
Digital RF input (coaxial)	50 mVp-p~200 mVp-p

### FM Tuner section

Tuning frequency range	87.5 MHz~108 MHz
Usable sensitivity	
MONO	1.6 $\mu$ V (at 75 $\Omega$ ) / 15.2 dBf (75 kHz dev., SINAD. 30 dB)
50dB quieting sensitivity	
STEREO	31.6 $\mu$ V (at 75 $\Omega$ ) / 41.2 dBf (75 kHz dev.)
Signal to noise ratio (1 kHz, 75 kHz dev.)	
MONO	75 dB (65.2 dBf input)
STEREO	68 dB (65.2 dBf input)
Selectivity (IHF $\pm$ 400 kHz)	50 dB
Stereo separation (1 kHz)	40 dB
Frequency response	30 Hz~15 kHz, + 0.5 dB, - 3.0 dB

### AM Tuner section

Tuning frequency range	(9 kHz) 531 kHz ~ 1,602 kHz (10 kHz) 530 kHz ~ 1,610 kHz
Usable sensitivity (30% mod., S/N 20 dB)	16 $\mu$ V / (600 $\mu$ V / m)
Signal to noise ratio (at 30% mod. 1mV input)	48 dB

### General

Power consumption	35 W
AC outlet	
UN SWITCHED	2: (Total 100 W max) (Australia 1:(100 W max))
Dimensions	W:400 mm H:105 mm D:382 mm
Weight (net)	5.2 kg



1. KENWOOD follows a policy of continuous advancements in development. For this reason specifications may be changed without notice.  
2. Full performance may not be exhibited in extremely cold locations (below 0 deg C)

**⚠ Caution : Read this page carefully to ensure safe operation.**

## For C-V550

### Audio section

Total harmonic distortion (1 kHz, 1V)	0.01 %
Signal to noise ratio (IHF'66)	
CD	98 dB
Input sensitivity / impedance	
CD	200 mV / 47kΩ
Tone controls	
BASS	± 8 dB (at 100 Hz)
TREBLE	± 8 dB (at 10 kHz)
Output level / impedance	
TAPE REC	200 mV / 1 kΩ

### Video section

VIDEO inputs / outputs	
(composite)	1 Vp-p/75 Ω

### Digital section

Sampling frequency	32 kHz, 44.1 kHz, 48 kHz
Digital input	
(coaxial)	0.5 Vp-p/75 Ω
Digital RF input	
(coaxial)	50 mVp-p~200 mVp-p

### FM Tuner section

Tuning frequency range	87.5 MHz~108 MHz
Usable sensitivity	
MONO	1.6 μV (at 75 Ω) / 15.2 dBf (75 kHz dev., SINAD. 30 dB)
50dB quieting sensitivity	
STEREO	31.6 μV (at 75 Ω) / 41.2 dBf (75 kHz dev.)
Signal to noise ratio (1 kHz, 75 kHz dev.)	
MONO	75 dB (65.2 dBf input)
STEREO	68 dB (65.2 dBf input)
Selectivity (IHF ± 400 kHz)	50 dB
Stereo separation (1 kHz)	40 dB
Frequency response	30 Hz~15 kHz, + 0.5 dB, - 3.0 dB

### AM Tuner section

Tuning frequency range	(9 kHz) 531 kHz ~ 1,602 kHz (10 kHz) 530 kHz ~ 1,610 kHz
Usable sensitivity	
(30% mod., S/N 20 dB)	16 μV / (600 μV / m)
Signal to noise ratio	
(at 30% mod. 1mV input)	48 dB

### General

Power consumption	35 W
AC outlet	
UN SWITCHED	2: (Total 100 W max) (Australia 1:(100 W max))
Dimensions	W:400 mm H:105 mm D:382 mm
Weight (net)	4.4 kg



1. KENWOOD follows a policy of continuous advancements in development. For this reason specifications may be changed without notice.
2. Full performance may not be exhibited in extremely cold locations (below 0 deg.C).

⚠ **Caution : Read this page carefully to ensure safe operation.**

## For C-V500

(U.S.A. and Canada)

### Audio section

Total harmonic distortion (1 kHz, 1V)	0.01 %
Signal to noise ratio (IHF'66)	
CD	98 dB
Input sensitivity / impedance	
CD	200 mV / 47k $\Omega$
Tone controls	
BASS	$\pm 8$ dB (at 100 Hz)
TREBLE	$\pm 8$ dB (at 10 kHz)
Output level / impedance	
TAPE REC	200 mV / 1 k $\Omega$

### Video section

VIDEO inputs / outputs (composite)	1 Vp-p/75 $\Omega$
---------------------------------------	--------------------

### Digital section

Sampling frequency	32 kHz, 44.1 kHz, 48 kHz
Digital input (coaxial)	0.5 Vp-p/75 $\Omega$

### FM Tuner section

Tuning frequency range	87.5 MHz~108 MHz
Usable sensitivity	
MONO	1.6 $\mu$ V (at 75 $\Omega$ ) / 15.2 dBf (75 kHz dev., SINAD. 30 dB)
50dB quieting sensitivity	
STEREO	31.6 $\mu$ V (at 75 $\Omega$ ) / 41.2 dBf (75 kHz dev.)
Signal to noise ratio (1 kHz, 75 kHz dev.)	
MONO	75 dB (65.2 dBf input)
STEREO	68 dB (65.2 dBf input)
Selectivity (IHF $\pm$ 400 kHz)	70 dB
Stereo separation (1 kHz)	40 dB
Frequency response	30 Hz~15 kHz, + 0.5 dB, - 3.0 dB

### AM Tuner section

Tuning frequency range	530 kHz ~ 1,700 kHz
Usable sensitivity (30% mod., S/N 20 dB)	16 $\mu$ V / (600 $\mu$ V / m)
Signal to noise ratio (at 30% mod. 1mV input)	48 dB

### General

Power consumption	35 W
⚡ AC outlet	
UN SWITCHED	2: (Total 100 W max)
Dimensions	W:400 mm (15-3/4") H:105 mm (4-1/8") D:382 mm (15-1/16")
Weight (net)	4.4 kg (9.7 lb)

## For C-V500

(Other countries)

### Audio section

Total harmonic distortion (1 kHz, 1V)	0.01 %
Signal to noise ratio (IHF'66)	
CD	98 dB
Input sensitivity / impedance	
CD	200 mV / 47k $\Omega$
Tone controls	
BASS	$\pm 8$ dB (at 100 Hz)
TREBLE	$\pm 8$ dB (at 10 kHz)
Output level / impedance	
TAPE REC	200 mV / 1 k $\Omega$

### Video section

VIDEO inputs / outputs (composite)	1 Vp-p/75 $\Omega$
---------------------------------------	--------------------

### Digital section

Sampling frequency	32 kHz, 44.1 kHz, 48 kHz
Digital input (coaxial)	0.5 Vp-p/75 $\Omega$

### FM Tuner section

Tuning frequency range	87.5 MHz~108 MHz
Usable sensitivity	
MONO	1.6 $\mu$ V (at 75 $\Omega$ ) / 15.2 dBf (75 kHz dev., SINAD. 30 dB)
50dB quieting sensitivity	
STEREO	31.6 $\mu$ V (at 75 $\Omega$ ) / 41.2 dBf (75 kHz dev.)
Signal to noise ratio (1 kHz, 75 kHz dev.)	
MONO	75 dB (65.2 dBf input)
STEREO	68 dB (65.2 dBf input)
Selectivity (IHF $\pm$ 400 kHz)	50 dB
Stereo separation (1 kHz)	40 dB
Frequency response	30 Hz~15 kHz, + 0.5 dB, - 3.0 dB

### AM Tuner section

Tuning frequency range	(9 kHz) 531 kHz ~ 1,602 kHz (10 kHz) 530 kHz ~ 1,610 kHz
Usable sensitivity (30% mod., S/N 20 dB)	16 $\mu$ V / (600 $\mu$ V / m)
Signal to noise ratio (at 30% mod. 1mV input)	48 dB

### General

Power consumption	35 W
⚡ AC outlet	
UN SWITCHED	2: (Total 100 W max)
Dimensions	W:400 mm H:105 mm D:382 mm
Weight (net)	4.4 kg



1. KENWOOD follows a policy of continuous advancements in development. For this reason specifications may be changed without notice.
2. Full performance may not be exhibited in extremely cold locations (below 0 deg.C)

# In case of difficulty

CV770/CV700/CV550/CV500 (E)/M

What appears to be a multifunction may not always be serious. If your unit should not perform as expected, consult the table below to see if the problem can be corrected before seeking help from your dealer or service representative.

## How to reset the microcomputer

The microcomputer may malfunction (impossibility of operation, erroneous display, etc.) when the power cord is unplugged and plugged in again while the unit is in ON mode with the I/⏻ key pressed or due to other external causes. In this case, execute the procedure on the right to reset the microcomputer and return the unit to the normal condition.

- 1 Unplug the power cord from the wall outlet.
- 2 While pressing and holding the POWER or I/⏻ (ON/STANDBY) key, plug the AC cord into the wall outlet again.

- Resetting the microcomputer clears the memory you entered and returns it to the initial condition when the unit left the factory.

## Amplifier

Symptom	Cause	Remedy
Sound is not output or the volume level is low.	<ul style="list-style-type: none"> <li>● Connection cords are unplugged from the jacks</li> <li>● MUTE is ON. (The MUTE ON indicator is blinking)</li> <li>● The TAPE 2 (MONITOR) key is set to ON</li> <li>● The selected surround mode does not match the input signal</li> </ul>	<ul style="list-style-type: none"> <li>● Connect them properly referring to "System connections" → 5 → 9</li> <li>● Press the MUTE key to OFF → 26</li> <li>● Set the TAPE 2 (MONITOR) key to OFF</li> <li>● Select the surround mode according to the input signal → 37</li> </ul>
"PROTECT" blinks and sound is not output.	<ul style="list-style-type: none"> <li>● Speaker cords are short circuited.</li> </ul>	<ul style="list-style-type: none"> <li>● Unplug the AC cord, remove the short-circuiting and plug the AC cord again</li> </ul>
Sound is not output from one of the speakers.	<ul style="list-style-type: none"> <li>● The BALANCE control is set to an extreme position.</li> </ul>	<ul style="list-style-type: none"> <li>● Adjust the Left/Right balance → 25</li> </ul>
Sound is not output from the surround speaker and/or center speaker, or their sound is very small.	<ul style="list-style-type: none"> <li>● The surround speaker cords and/or center speaker cord are disconnected</li> <li>● The Surround play mode has not been engaged.</li> <li>● The surround and center speaker levels are set to the minimum positions</li> </ul>	<ul style="list-style-type: none"> <li>● Connect them by referring to the power amplifier's instruction manual</li> <li>● Set the presence mode → 35</li> <li>● Adjust the surround and center speaker levels</li> </ul>
System control is not available when TAPE1 or MD is selected.	<ul style="list-style-type: none"> <li>● "TAPE1" or "MD" is not displayed</li> </ul>	<ul style="list-style-type: none"> <li>● Switch the display to "TAPE 1" or "MD" → 10</li> </ul>
System control is not available when DVD or 6ch INPUT is selected.	<ul style="list-style-type: none"> <li>● "DVD" or "6ch INPUT" is not displayed</li> </ul>	<ul style="list-style-type: none"> <li>● Switch the display to show "DVD" or "6ch INPUT" → 19</li> </ul>
System control is impossible.	<ul style="list-style-type: none"> <li>● System control cords are connected incorrectly</li> </ul>	<ul style="list-style-type: none"> <li>● Connect them correctly by referring to "System connection"</li> </ul>

## Tuner

Symptom	Cause	Remedy
Radio stations cannot be received.	<ul style="list-style-type: none"> <li>● No antenna is connected.</li> <li>● The broadcast band is not set properly</li> <li>● The frequency of the desired station is not tuned.</li> </ul>	<ul style="list-style-type: none"> <li>● Connect an antenna → 9</li> <li>● Set the broadcast band properly → 28</li> <li>● Tune the frequency of the desired station → 28</li> </ul>
Interference.	<ul style="list-style-type: none"> <li>● Noise due to ignition noise of an automobile.</li> <li>● Noise due to an influence from an electric appliance.</li> <li>● Noise due to a nearby TV set.</li> </ul>	<ul style="list-style-type: none"> <li>● Install the outdoor antenna away from the road.</li> <li>● Turn off the power to the appliance.</li> <li>● Install the system farther away from the TV set</li> </ul>
A station which was preset cannot be received by pressing the corresponding numeric key.	<ul style="list-style-type: none"> <li>● The preset memory was cleared because the power cord had been unplugged for a long period of time.</li> <li>● The TUNER input is not selected.</li> </ul>	<ul style="list-style-type: none"> <li>● Preset the stations by auto memory again. → 29</li> <li>● Select the TUNER input.</li> </ul>



Do not use contact cleaning agents because they could cause a malfunction. Be specifically careful against using contact cleaning agents containing oil, since they may deform the plastic components.



**Remote control unit**

Symptom	Cause	Remedy
Remote control operation is not possible.	<ul style="list-style-type: none"> <li>Batteries are exhausted.</li> <li>The remote control unit is too far away from the main system, controlling angle is too large, or there is an obstacle in between.</li> <li>The audio cords and system control cords are not connected properly.</li> <li>The source component to be operated does not contain the tape(s) or disc.</li> </ul>	<ul style="list-style-type: none"> <li>Replace with new batteries. — 15.</li> <li>Operate the remote control unit within the controllable range. — 14.</li> <li>Connect properly referring to "System connection" — 5, — 8.</li> <li>Place the tape(s) or disc in the source component to be played.</li> </ul>
The GRC screen is not displayed.	<ul style="list-style-type: none"> <li>Batteries are exhausted.</li> </ul>	<ul style="list-style-type: none"> <li>Replace with new batteries. — 15.</li> </ul>
The GRC display is abnormal.	<ul style="list-style-type: none"> <li>Batteries are removed while something is displayed.</li> </ul>	<ul style="list-style-type: none"> <li>Remove and replace batteries after the information display has disappeared.</li> </ul>

**Set up code chart**

Although each setup code is designed to work with a number of different models, certain codes may not work with some models. (Also, certain codes may only operate some of the functions available on a given model.) With some models, be sure to keep the **ENTER** key pressed for a while.

**Memory backup function**

Please note that the following items will be deleted from this unit's memory if the power cord is disconnected from the AC outlet for approximately three days.

- The input selection is cleared and the TUNER input is selected.
- The volume setting is cleared and the volume is set to -65 dB.
- The receiving band setting is cleared and the FM band is selected.
- The frequency setting is cleared and 87.5 MHz is selected.
- The preset station memory is cleared.
- The voice activation setting is cleared and the activation by non-specified person is set.
- The surround setting is cleared and reset to the initial condition.
- The clock and timer setup is cleared and the clock display shows AM 12:00 which is blinking.

**For the U.S.A.****FCC WARNING**

This equipment may generate or use radio frequency energy. Changes or modifications to this equipment may cause harmful interference unless the modifications are expressly approved in the instruction manual. The user could lose the authority to operate this equipment if an unauthorized change or modification is made.

**NOTE:**

This equipment has been tested and found to comply with the limits for a Class B digital device, pursuant to Part 15 of the FCC Rules. These limits are designed to provide reasonable protection against harmful interference in a residential installation. This equipment may cause harmful interference to radio communications, if it is not installed and used in accordance with the instructions. However, there is no guarantee that interference will not occur in a particular installation. If this equipment does cause harmful interference to radio or television reception, which can be determined by turning the equipment off and on, the user is encouraged to try to correct the interference by one or more of the following measures:

- Reorient or relocate the receiving antenna.
- Increase the separation between the equipment and receiver.
- Connect the equipment into an outlet on a circuit different from that to which the receiver is connected.
- Consult the dealer or an experienced radio / TV technician for help.

**For the U.S.A.****Note to CATV system installer:**

This reminder is provided to call the CATV system installer's attention to Article 820-40 of the NEC that provides guidelines for proper grounding and, in particular, specifies that the cable ground shall be connected to the grounding system of the building, as close to the point of cable entrance as practical.